

Anritsu envision : ensure

Microwave Site Master™

Cable & Antenna Analyzer with Optional
VNA & VVM Modes

S820E

1 MHz to 8 GHz, 14 GHz, 20 GHz, 30 GHz, 40 GHz

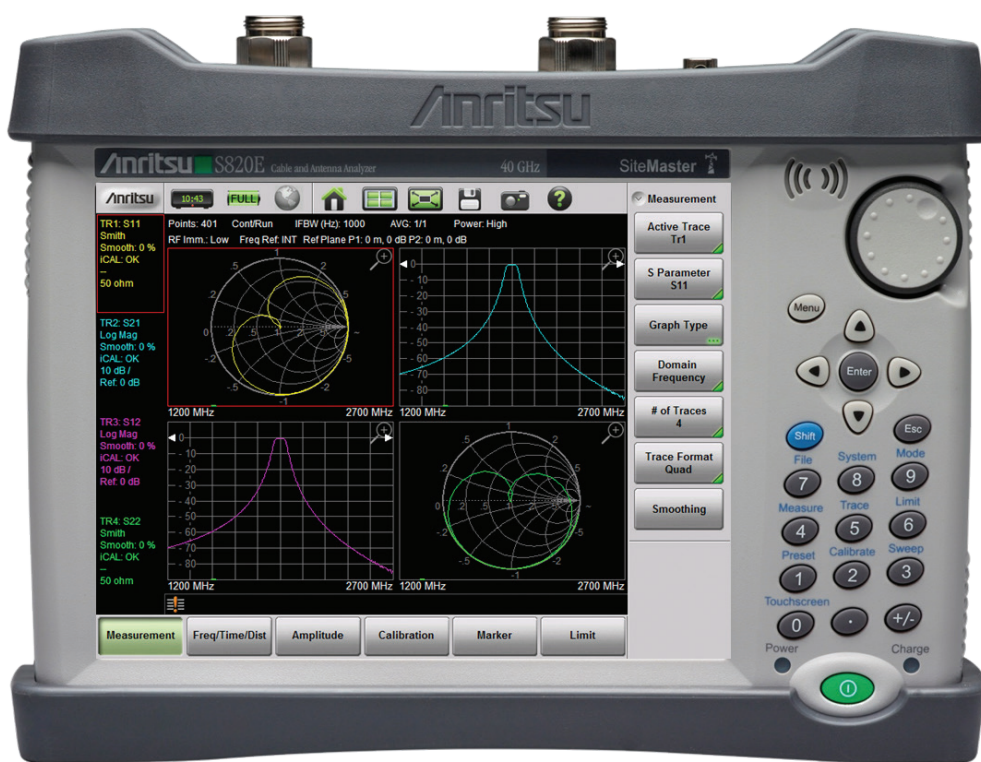

Microwave Site Master S820E Cable & Antenna Analyzer Overview

Site Master is the Preferred Cable and Antenna Analyzer of Wireless Service Providers, Contractors, and Installers Worldwide

The Site Master S820E is the most advanced Site Master ever developed. With microwave frequency coverage up to 40 GHz. The Site Master S820E has redefined the standards for portable handheld analyzers, setting another new industry benchmark for performance and accuracy. The Site Master S820E is the culmination of >50 years of microwave development, utilizing the very latest technologies to deliver accuracy and performance previously reserved only for benchtop instruments. Fully equipped with 4 VNA receivers (a1, a2, b1, b2), the Site Master S820E offers true VNA performance in a portable package.



Site Master S820E Family

Standard Capabilities Include:

1. More **standard** features than any other microwave cable/antenna analyzer on the market

1-Path, 2-Port measurements	USB Transmission measurements	Smith Chart	1-Port Phase	High Accuracy Power Meter	Pass/Fail Fiber Visual Inspection	Built-in Help Menu and full User Guide
-----------------------------	-------------------------------	-------------	--------------	---------------------------	-----------------------------------	--

2. Unique, simultaneous reflection (VSWR or RL) plus extended USB transmission measurement across frequency range of interest with a single calibration. Dual display of results with independent limit lines and pass/fail analysis
3. Unprecedented dynamic range of 110 dB all the way up to 40 GHz for real benchtop performance in the field
4. Best frequency resolution of 1 Hz throughout entire operating range for maximum frequency flexibility
5. Fast sweep speed of $\leq 550 \mu\text{s}$ /data point for fast field measurements
6. Full temperature coax calibration kits from -10°C to $+55^\circ\text{C}$ for field precision measurement
7. Wide calibration temperature window of $\pm 10^\circ\text{C}$ requiring less recalibrations
8. Highest RF immunity of +17 dBm for operation in harsh RF environments
9. Explosive Atmosphere MIL-PRF-28800F Section 4.5.6.3 compliant
10. Active thermal management enables fastest warmup, unmatched stability, and reduces need to re-calibrate
11. Longest battery life with >5 hours of operation for the most field uptime on one charge
12. Large, high-resolution display (8.4 inch, 800x600) for maximum readability in all lighting conditions with an intuitive touchscreen graphical user interface

Microwave Site Master S820E Cable & Antenna Analyzer Overview

Nonlinear Transmission Line (NLTL) Sampler Technology (aka, Shockline) onboard Site Master S820E

Vector network analyzers (VNA) are precise measuring instruments that have been in use since their initial introduction several decades ago. Like most measuring instruments, they convert signals to an intermediate frequency (IF) and then process the signals. There are two traditional methods of converting signals to IF: one method is to employ mixers, another method is to employ samplers. Each conversion method has benefits as well as deficits. Mixers tend to work best at lower frequencies, whereas samplers are much more efficient at higher frequencies. Fortunately, the Site Master S820E actually employs both methods, each one optimized for the range that it operates in. Models with coverage beyond 8 GHz employ Anritsu's NLTL sampler technology above 8 GHz. The benefits of the NLTL sampler conversion methods compared to mixer based conversion methods are outlined below.

- 1. Superior Conversion Efficiency in Microwave Bands:** As test frequencies increase, mixer-based conversion relies on using n order mixer harmonics, where each of those harmonics gets progressively lower in amplitude as the n harmonic order of the mixer increases. To combat this increasing loss in conversion efficiency, additional amplifiers are required to increase the signal levels in order to be able to perform analysis on the signals. Each additional amplifier adds the following unwanted characteristics: reduced stability, reduced linearity, increased noise figure, increased distortion and harmonics, increased power consumption, and increased heat generation.
- 2. Increased Reliability:** Because Shockline NLTL technology is so much more efficient than traditional mixer-based technology, fewer amplifiers are needed in the IF stages. Fewer active components directly results in higher reliability, better stability, and lower power consumption.
- 3. Improved Linearity:** Active devices, such as amplifiers, are subject to nonlinear behavior. This is true for any component that is not purely passive. Since fewer IF amplifiers are required, the immediate results are improved linearity overall.
- 4. Increased Stability:** A welcome characteristic of the Shockline NLTL technology used in the Site Master S820E over mixer-based technology is significantly better stability over time, which directly equates to less measurement drift, longer intervals between calibrations, and superior repeatability and accuracy.
- 5. Lower Power Consumption:** Since fewer amplifiers are needed, less power is consumed. The resulting reduction in power consumption delivers several primary and secondary benefits. Primary benefits include longer battery operation times and less internal heat generated. Secondary benefits include faster cooling of the instrument and lighter weight since less heat sinking material is needed to manage instrument temperatures.
- 6. Highest Dynamic Range and Superior Accuracy:** The total outcome of the benefits of Shockline NLTL sampler technology are easily apparent and directly available with the Site Master S820E. 110 dB of dynamic range up to 40 GHz in a portable, handheld VNA instrument is without equal. Never before has there been this much performance in such a small package.

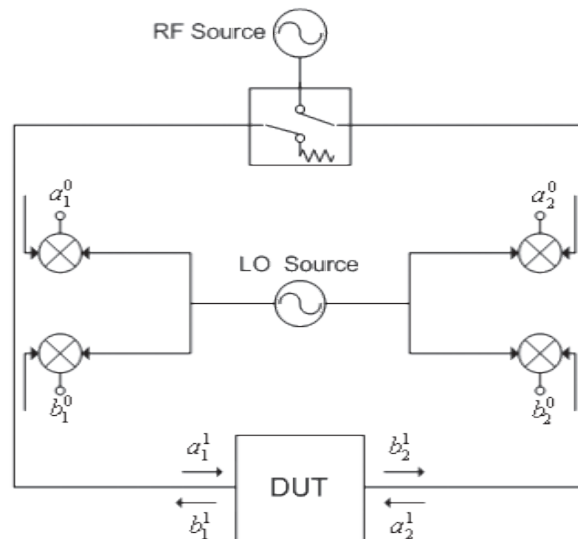

Equivalent simplified block diagram of Site Master S820E VNA-based 4

Microwave Site Master S820E Cable & Antenna Analyzer Standard Features



Cable & Antenna Analyzer



The Site Master S820E is purposely designed for use in the field

Rugged, Reliable, Lightweight, and Portable

Site Master S820E is rugged, reliable, field-proven, and always ready. At only 3.0 kg (6.6 lbs) including battery, it's effortless to carry whether you are on level ground, climbing a large tower, or heading through a roof hatch. Your Site Master easily goes along with you.



Inside special test chamber filled with volatile Hexane mixture

MIL-PRF-28800F Explosive Atmosphere Compliant

The Site Master S820E has been designed and tested to meet the MIL-PRF-28800F Section 4.5.6.3 Explosive Atmosphere requirements for safe usage on flight decks and in areas where high volatility may exist.

Superior Battery Operating Time

The Microwave Site Master S820E provides the longest battery operation time of any handheld microwave analyzer available today. With >5 hours of continuous usage (40 GHz model, typical), you will not have to waste valuable time looking for available AC power to complete the measurements you need while on site.

Also included are intelligent power saving features like sleep mode with instant on (handy for travelling between sites) and auto-display brightness that will reduce the screen backlight automatically if the instrument has not been accessed for some time. One touch of the screen, keypad, or wheel will automatically restore brightness levels.

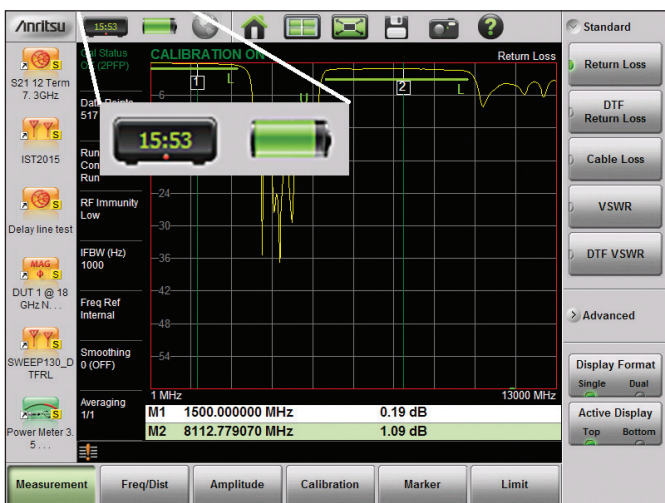

Provides long battery time ideal for field use

Microwave Site Master S820E Cable & Antenna Analyzer Standard Features



Cable & Antenna Analyzer

Efficient Menu Screen

The Menu Key activates the touchscreen menu for one-button access to all of the analyzer modes and quick access to the dedicated setup shortcut icons.



Main menu screen provides one touch mode selection and access to setup shortcuts

On-Board 1-Touch Help

An intelligent, useful help menu launches with the press of the Help Icon. The entire User Guide is built-in, as well as some useful FAQs and easy access to full system information.

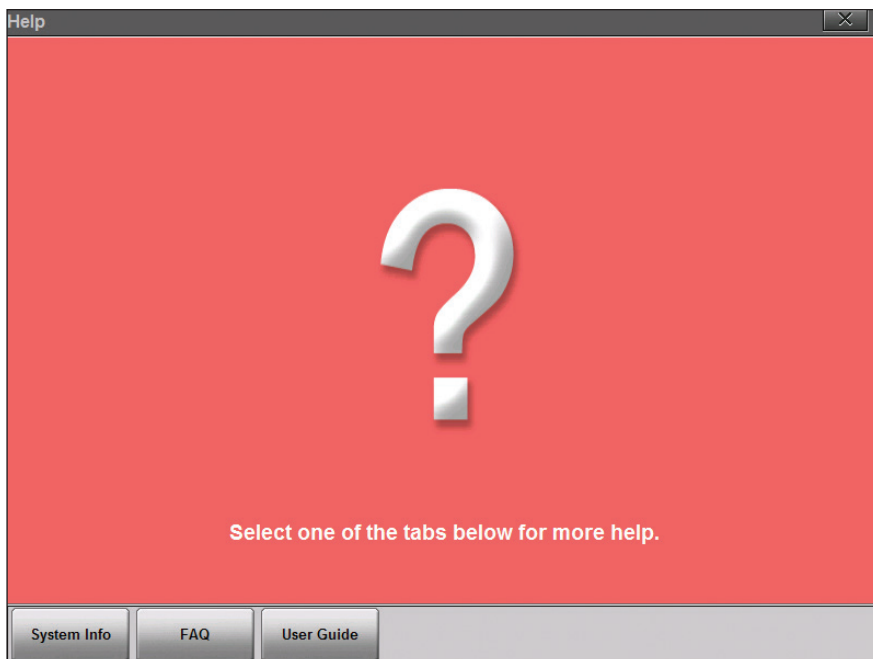

On screen Help Menu

Microwave Site Master S820E Cable & Antenna Analyzer Standard Features



Cable & Antenna Analyzer

Site Master S820E Delivers the Most Standard Measurements* of Any Microwave Hand-held Analyzer

The Site Master S820E delivers the most standard measurement capabilities of any microwave handheld analyzer: 2-port transmission, Smith Chart, phase, USB sensor transmission, high-accuracy power, visual fiber inspection, and dual display.

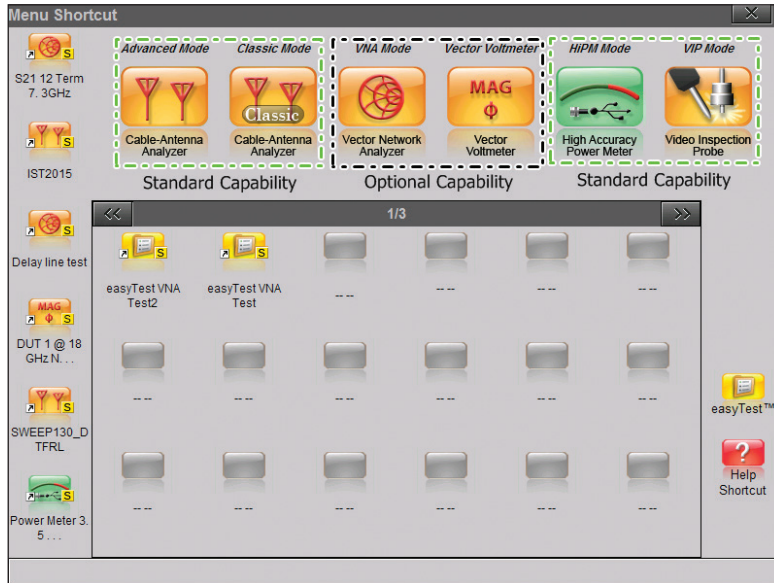

With the most standard measurements, the Site Master S820E provides extreme value



Classic Mode Provides Familiar GUI for Immediate Efficiency

For more than 20 years the Anritsu Site Master has been the defacto standard Cable & Antenna analyzer. In that time, many measurement procedures (MOP's) have been developed based on the original Site Master user interface and operation. For the user who needs to follow one of those MOP procedures, switching the S820E into Classic Mode will allow them to complete the tasks quickly and efficiently.

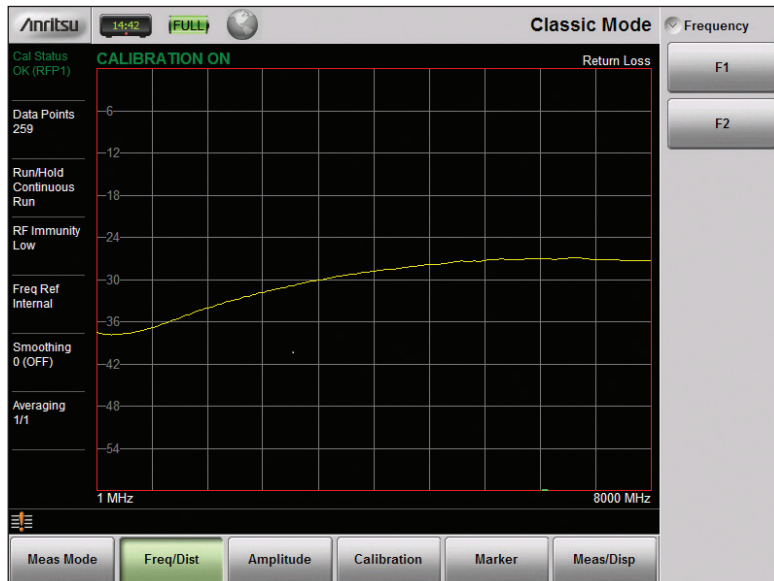

Classic Mode is standard on every Site Master S820E. Advanced Mode provides even more capabilities



Cable & Antenna Analyzer

Unprecedented Dynamic Range

The Site Master S820E delivers the most dynamic range ever offered in a handheld cable and antenna analyzer. With up to 110 dB of dynamic range, even at 40 GHz the Site Master S820E delivers performance that exceeds previous generation VNAs. You no longer have to sacrifice dynamic range in order to achieve the convenience of handheld portability.

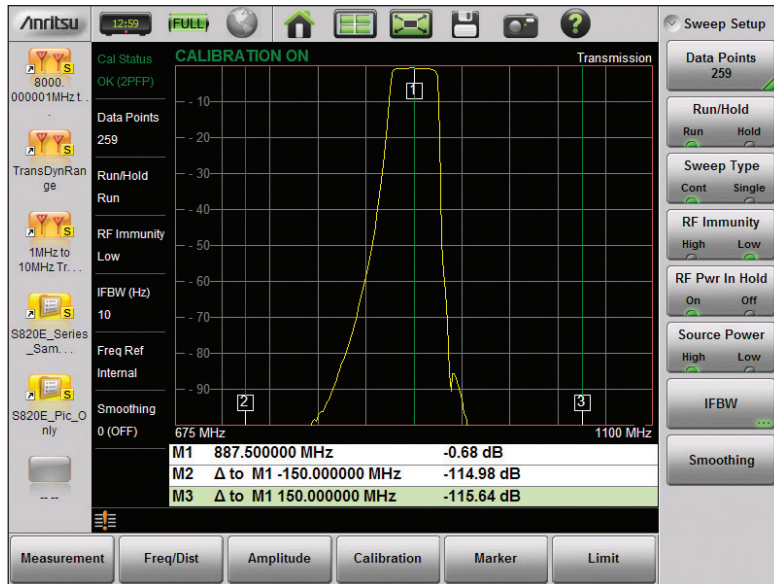

100 dB scale displayed with noise floor off screen. Delta markers indicate ~115 dB of dynamic range

Mixed Measurements with Dual Display

Flexible dual display allows users to simultaneously measure any two types of measurements. Depending on the measurement combination, independent calibrations may be applied to each measurement.

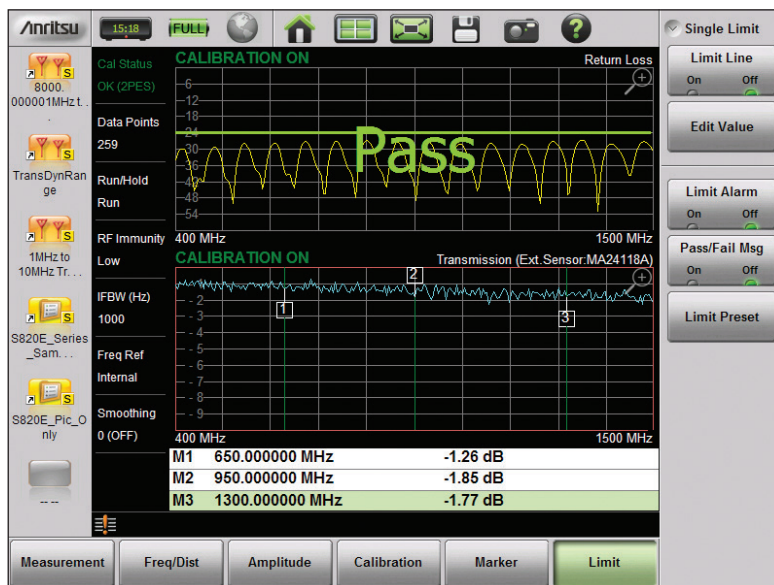

Return Loss (upper) displayed with 2-port USB Transmission (lower) using external USB Sensor

Microwave Site Master S820E Cable & Antenna Analyzer Standard Features



Cable & Antenna Analyzer

USB Sensor Transmission Measurement Solves Challenging Issues with Ease

There are countless scenarios where a transmission measurement needs to be made on fixed transmission lines. Some typical examples include coaxial cables within aircraft wings and fuselage, cables and/or waveguide installed in large naval vessels, submarine periscope cable assemblies, locomotive coaxial cables, coaxial cables installed in mine shafts, elevator shafts, tunnels, and so on. The Site Master S820E's USB sensor transmission measurement capability allows users to make those measurements quickly and efficiently. For long end-to-end distances, extending the USB Sensor is easily accomplished with the optional, low-cost extender kit available from Anritsu. Unlike similar competitive solutions, the Site Master S820E provides this unique capability while simultaneously making reflection (Return Loss or VSWR) measurements or distance-to-fault (DTF) measurements, and this capability does not require a mode change or multiple calibrations.



USB Transmission Sensor and extender kit shown connected to a Site Master S820E



Aircraft typically contain many embedded transmission lines that require validation at regular maintenance intervals

Microwave Site Master S820E Cable & Antenna Analyzer Standard Features



Cable & Antenna Analyzer

Calibration Made Easy Via Graphical Images and Guided Steps to Eliminate Errors

The Site Master S820E takes advantage of the large, high-resolution display to provide the user with detailed images showing the connector type as well as a guided, step-by-step calibration sequence. Once the required calibration steps have been completed, the user can then apply the calibration and begin making measurements. During calibration sweeps, the Site Master S820E emits a beep tone to alert the user that the sweep has completed and the next calibration component is ready to be measured. The screen continuously updates during calibration to indicate which step(s) of the calibration are completed until the entire sequence is complete. Even inexperienced users can confidently calibrate the Microwave Site Master S820E.

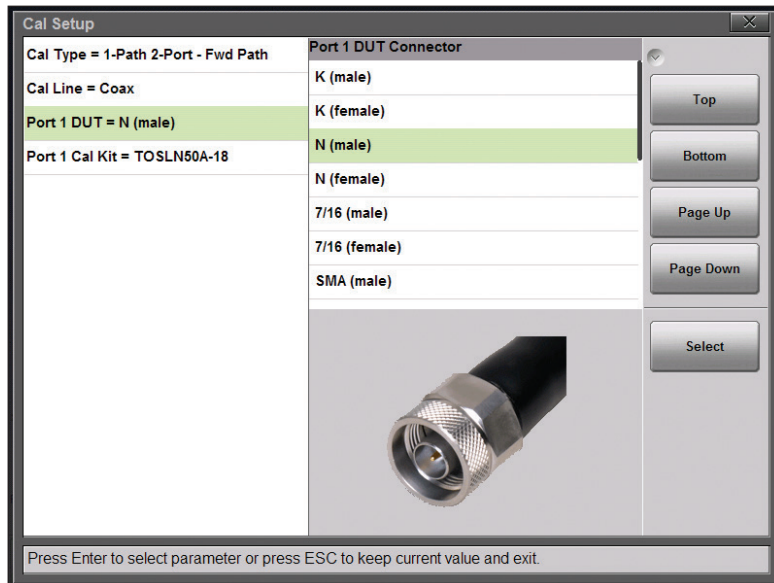

Site Master S820E displays images of the connector types to the user during calibration setup

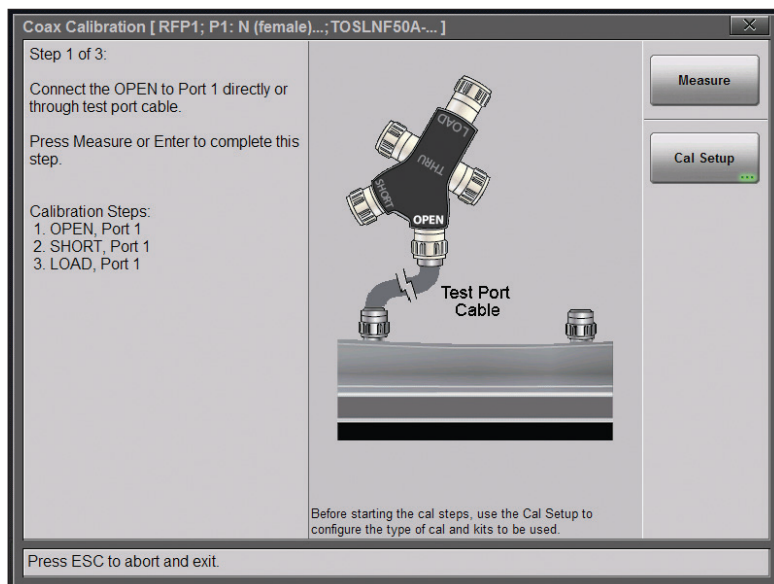

Step-by-step, guided calibration with live progress updates eliminates errors

Microwave Site Master S820E Cable & Antenna Analyzer Standard Features



Cable & Antenna Analyzer

Multiple Markers & Flexible Limits

The Site Master S820E has eight available markers per active trace, flexible limits (upper and/or lower) that can be either simple lines or segmented for specific testing needs, as well as built-in Pass/Fail testing and limit alarms that ensure your device under test is within its specifications.

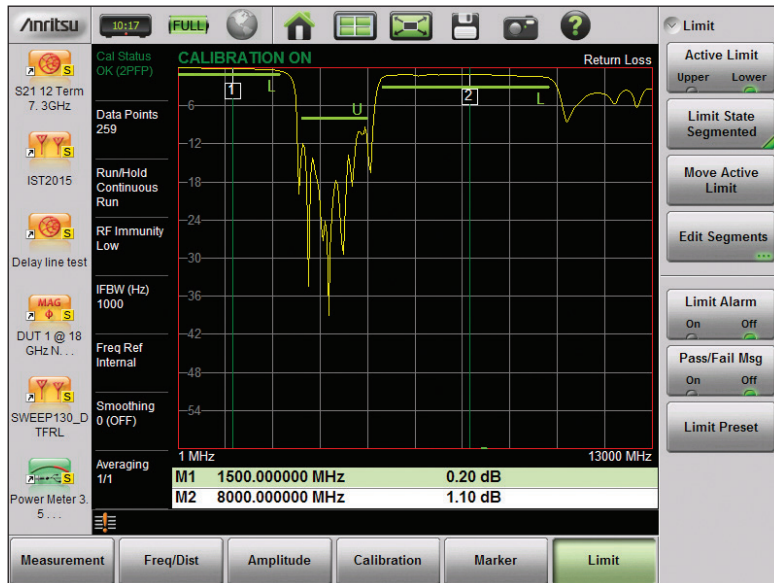

Markers can be moved simply by a touch/hold then drag, or by entering the marker frequency manually

Convenient Direct Access Shortcuts

Users can store their 6 favorite setups conveniently in the area highlighted for one-touch direct access. No need to go through the main menu or file menu to access those 6 setups. If your needs change, simply replace those setups with the latest to suit your needs. (Not available in Classic Mode).

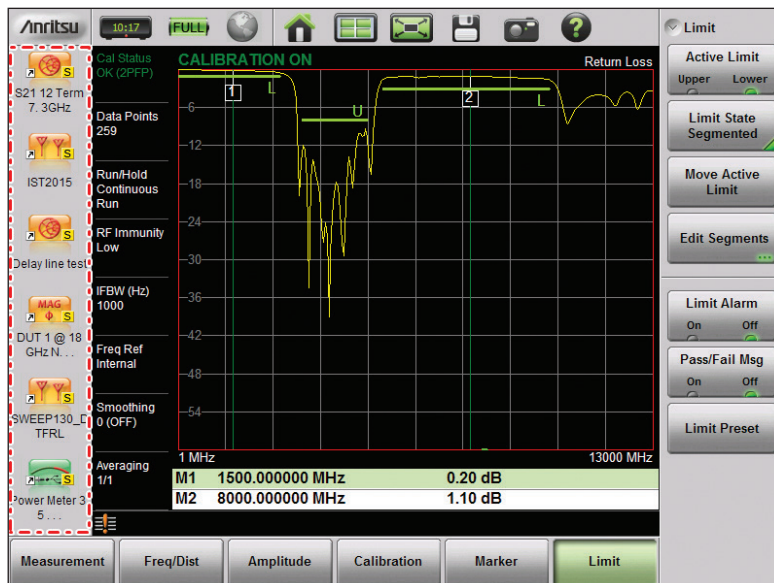

User-definable shortcuts for frequently used functions

Microwave Site Master S820E Cable & Antenna Analyzer Standard Features



Cable & Antenna Analyzer

Variable IFBW Settings to Optimize Speed and Performance

Unlike competitive products which offer only a single, fixed IFBW in Cable & Antenna analyzer mode, the Site Master S820E provides four user selectable IFBW settings to obtain the best performance/speed needed for the current task at hand. Excellent performance is provided by the default 1 kHz IFBW.

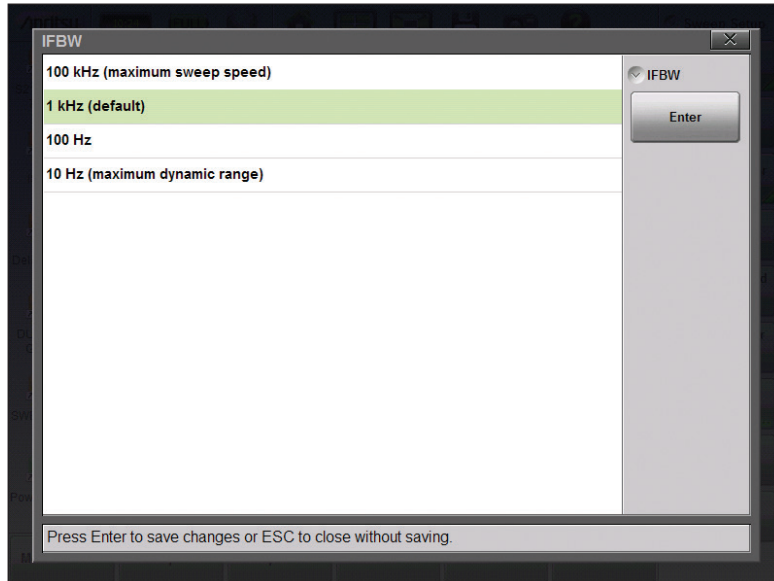

Users can easily adjust the IFBW to get increased speed or increased dynamic range anytime

DTF Aid Screen Makes Complex DTF Measurements Easy

DTF measurements are a powerful and valuable tool for field installation/maintenance of wireless communication systems. However, it can be challenging for some users. The Site Master S820E includes a very useful DTF-Aid screen to help the user with the setup of the instrument so that they can obtain the best and most accurate DTF measurements, enabling them to locate and correct the source of the problem quickly and efficiently.

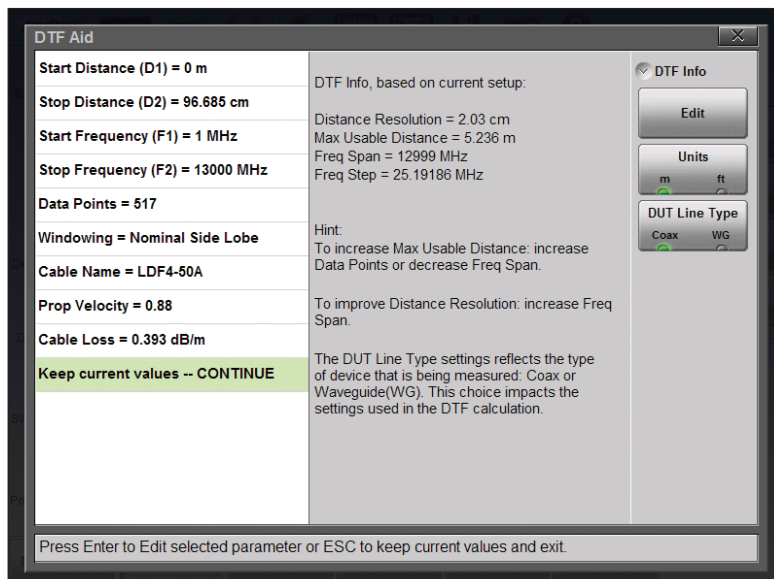

DTF-Aid screen also includes hints on how to optimize the settings even further

Microwave Site Master S820E Cable & Antenna Analyzer Standard Features



Cable & Antenna Analyzer



High-Accuracy Power Meter

The Site Master S820E includes a high-accuracy power meter mode for accurately measuring power in the field. This is a standard capability on every device, unlike some competitor's products that charge for this capability. Uses Anritsu external USB power sensors, sold separately.

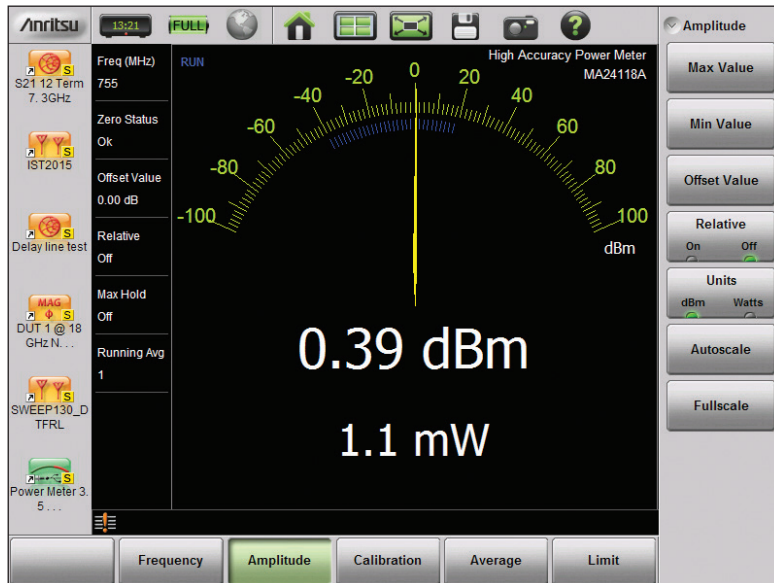

Built in High Accuracy Power Meter measurement screen



Fiber Optic Connector Pass/Fail Testing Using USB Visual Inspection Probe

Modern communication systems are rapidly evolving to meet growing data demands. To keep up with those demands, the majority of systems being installed today use Fiber Optic links to provide the high-speed data connection. Incredibly, 60 – 75% of all faults in these systems are due to damaged or dirty Fiber Optic connector ends. The Site Master S820E includes the IEC 61300-3-35 industry-standard test profiles, and provides fast and easy Pass/Fail testing of Fiber Optic connector ends. Only a separate Anritsu USB-based Fiber Optic Inspection Probe (sold separately) is required to perform these tests.

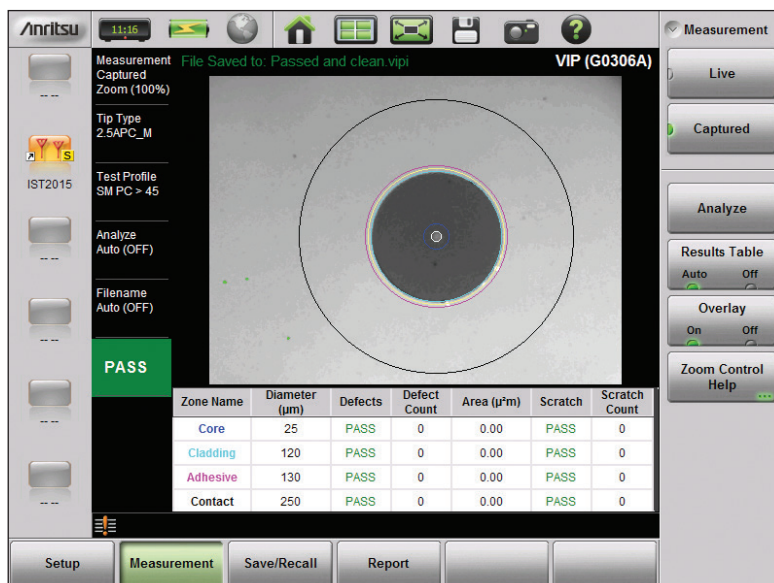

Example of a single-mode fiber connector end after cleaning. Zero defects and passing results

Microwave Site Master S820E Cable & Antenna Analyzer Standard Features



Cable & Antenna Analyzer

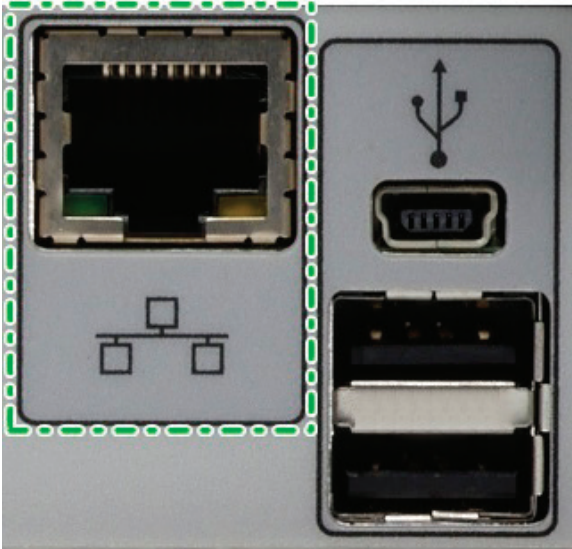

Standard Ethernet RJ-45 Port

The Site Master S820E comes standard with an RJ-45 Ethernet port. Connecting to any Ethernet network is as simple as connecting the cable and either setting the instrument to obtain an I.P. address automatically via DHCP, or if necessary users can enter their own manual I.P. address configuration. Full remote control of the instrument is available either using SCPI commands, or using the built-in web server with any device and HTML5 compatible browser. Add an external USB powered WiFi router and you now have complete wireless remote control of the instrument, using your favorite Android, IOS, or Windows® device.

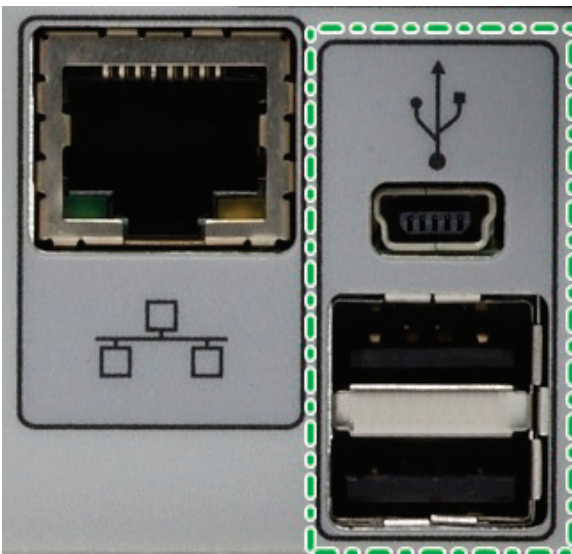

Standard Multiple USB Ports

The Site Master S820E comes standard with two USB type A ports, and 1 USB type mini B port. The type B mini USB port may be used for remote SCPI operation of the instrument or for transferring measurements to and from an external PC with the supplied Line Sweep Tools (LST) software. Two type A USB 2.0 ports support numerous external peripheral devices such as USB memory sticks, external mouse and/or keyboard, external USB Power Sensors, or an external Anritsu USB microscope for performing IEC-61300-3-35 pass/fail testing on Fiber Optic cable ends.



GUI Remote Control Via Built-in Web Server

The Site Master S820E has a built-in web server that enables remote control of the instrument that is connected to a network via the RJ-45 connector, or wirelessly with the addition of an external USB powered Wi-Fi router. Works with several HTML5 compatible web browsers. Once a valid network connection has been established, type in the IP address of the instrument in the URL field and a virtual instrument will appear in the browser display. You now have control of the instrument almost as if it was in front of you. Measurements and/or files are easily transferred into the remote PC or tablet. A virtual keypad replicates the instrument keypad and the scroll wheel function is replicated using the four arrow keys (up/down/left/right).

Microwave Site Master S820E Cable & Antenna Analyzer Standard Features



Cable & Antenna Analyzer

Large, Easy-to-see Touchscreen Keyboard

Unlike some competitive products, the Site Master S820E has a large, built-in popup keyboard that saves valuable time in the field when saving files, setups, etc. Time spent in the field is valuable and using a scroll wheel to select individual letters and characters one at a time is very time consuming and error-prone. With this large, QWERTY-style keyboard, saving files, setups, or anything else is done quickly with few (if any) errors. The time saved by this handy keyboard increases your efficiency and the returns will be quickly obvious and noticeable. You will find yourself wondering how you ever managed without this.

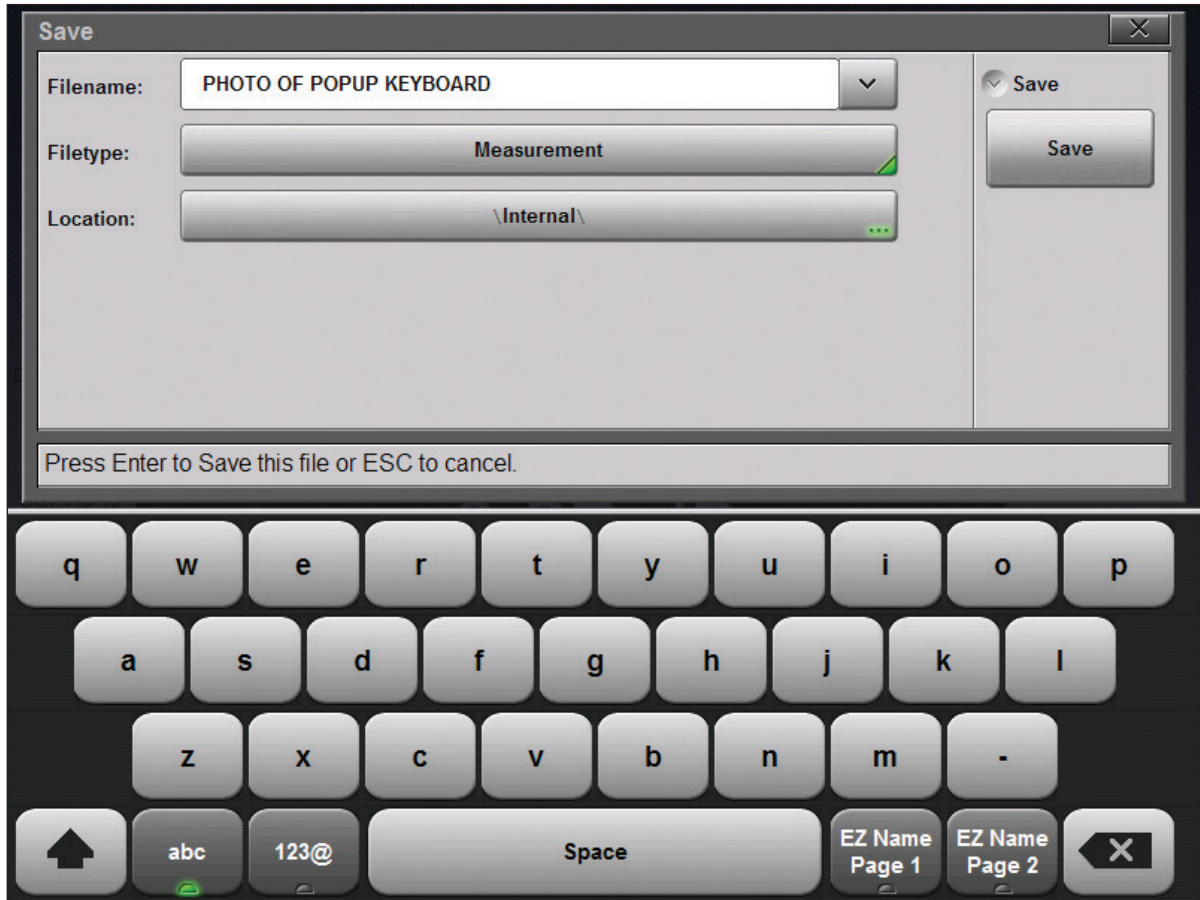

Buttons are large, easy to see and press even with gloves on. Makes file saving easier than ever.



Cable & Antenna Analyzer

EZ Name Quick Naming Matrix Saves Even More Valuable Time

Unique to Anritsu, the customizable EZ Name Quick Naming Matrix saves even more valuable time. Users can preset up to 36 commonly used names. The resulting time saved is immediately beneficial. You can now save file names labeled with Site ID, Sector, Color Code, Measurement type, Termination, and Frequency in less than 5 seconds. With the EZ Name Quick Matrix feature, you can now label the traces of the entire site in minutes instead of hours.

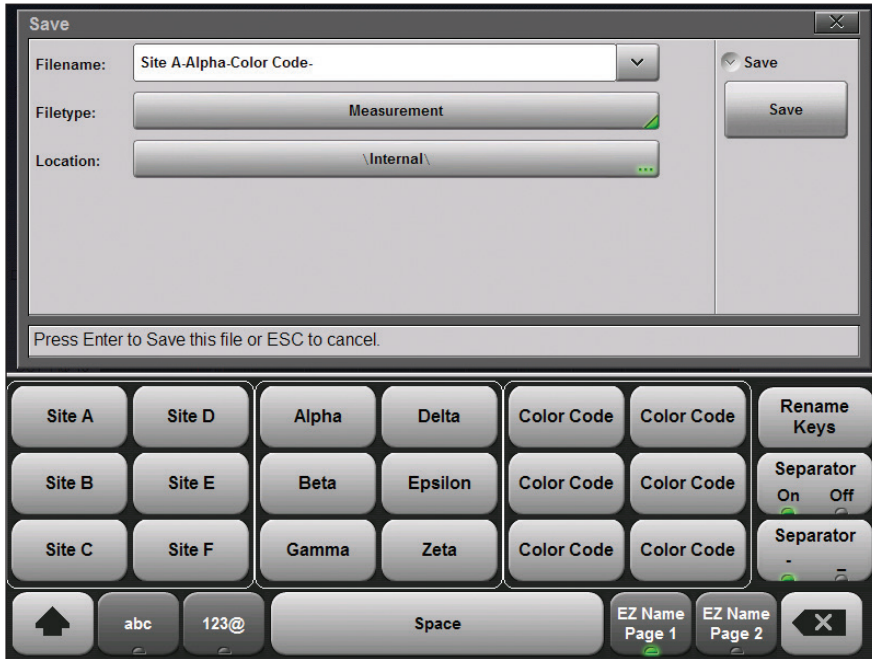

Most common site name requirements are preprogrammed into the EZ Name Matrix. Page 1 of 2 shown.

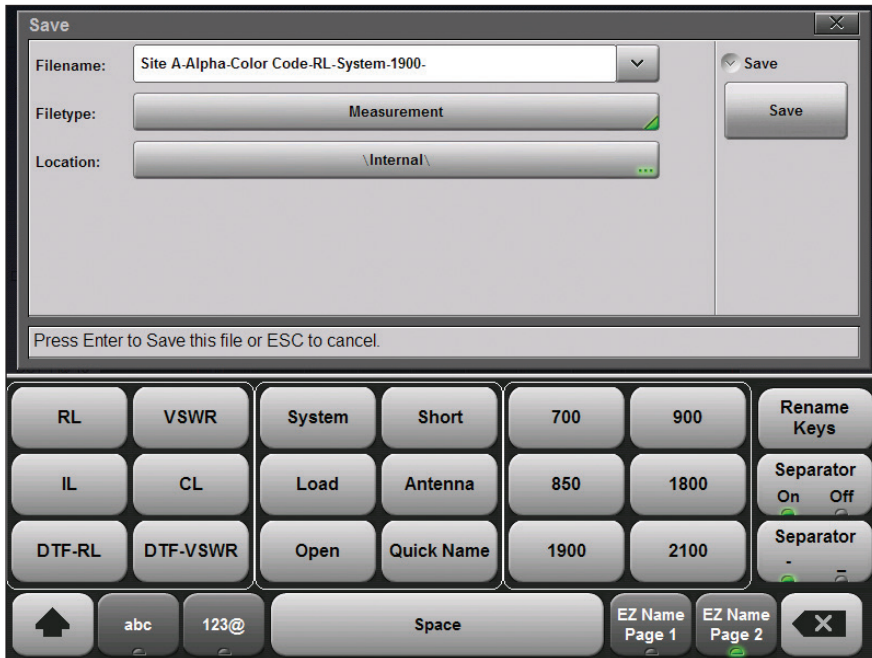

18 additional customizable EZ Name buttons available on page 2.

Microwave Site Master S820E Cable & Antenna Analyzer Available Options



Vector Network Analyzer (Option 440)

Fully Reversing VNA Mode

Adding Option 440 provides fully reversing Vector Network Analysis capability. Now users can measure all 4 S-parameters (S11, S12, S21, S22) with one single device connection. VNA Mode also provides several additional capabilities to the user that are not found in the standard Cable & Antenna Analyzer mode(s).

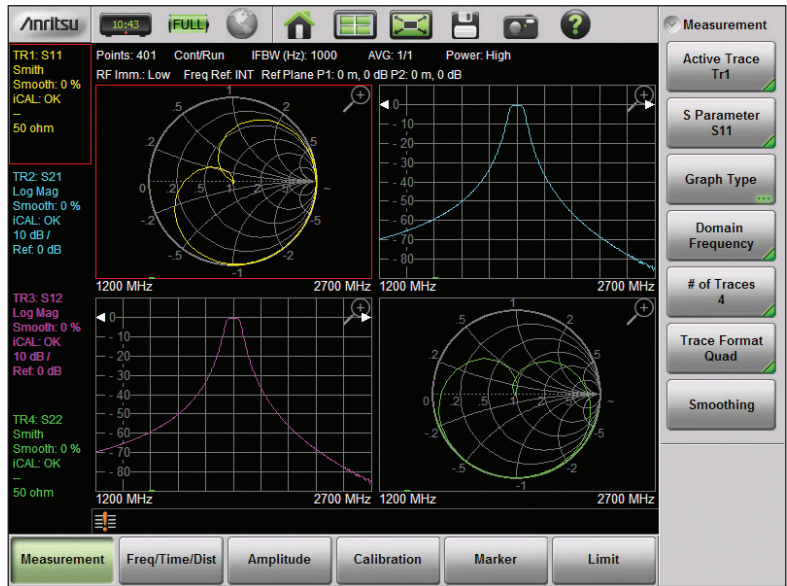

User configurable quad display showing all four S-parameters simultaneously

Optimize Speed and Dynamic Range Easily with Large Range of User Definable IFBW Settings

Experienced VNA users know that the dynamic range and sweep speed performance of the instrument is directly related to the IFBW used for the measurement. The Site Master S820E offer numerous user definable IFBW settings to achieve the best balance of both speed and dynamic range.

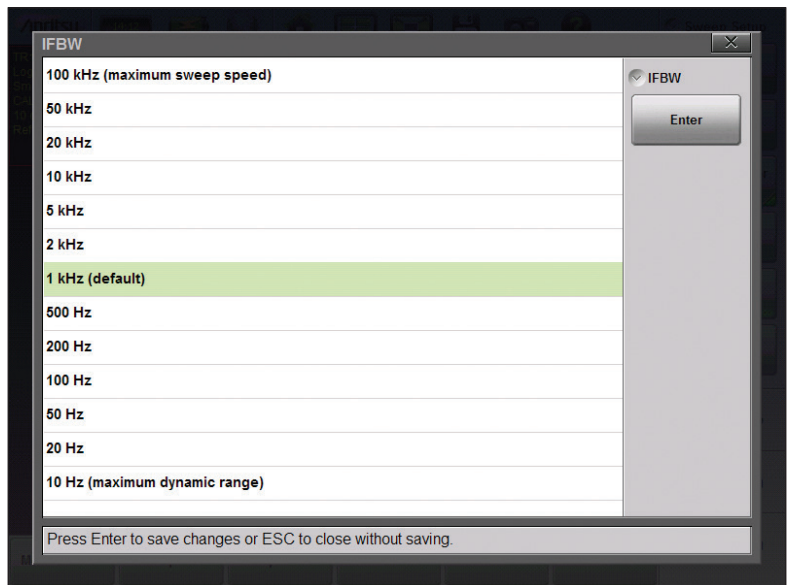

Default 1 kHz IFBW gives great blend of speed and dynamic range



Vector Network Analyzer (Option 440)

Easily Adjust Reference Plane in Distance or Time and Amplitude

Adjusting the reference plane is easily accomplished in the port config menu. Offset the reference plane in either distance or time and account for any losses in amplitude. Automatic Reference Plane extension quickly unwraps phase with a single button press. Use Automatic Reference Plane extension to quickly measure the electrical length of DUTs like adapters, tuning stubs, etc.

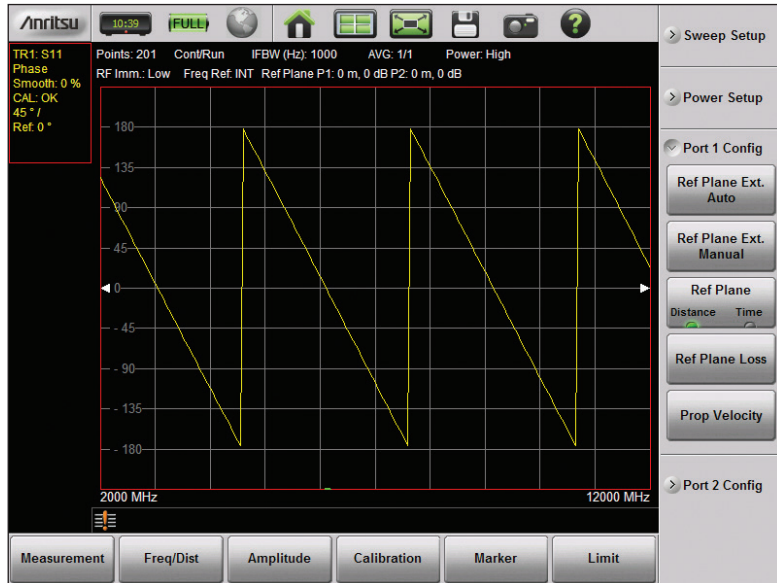

Before 1-button Automatic Reference Plane Extension

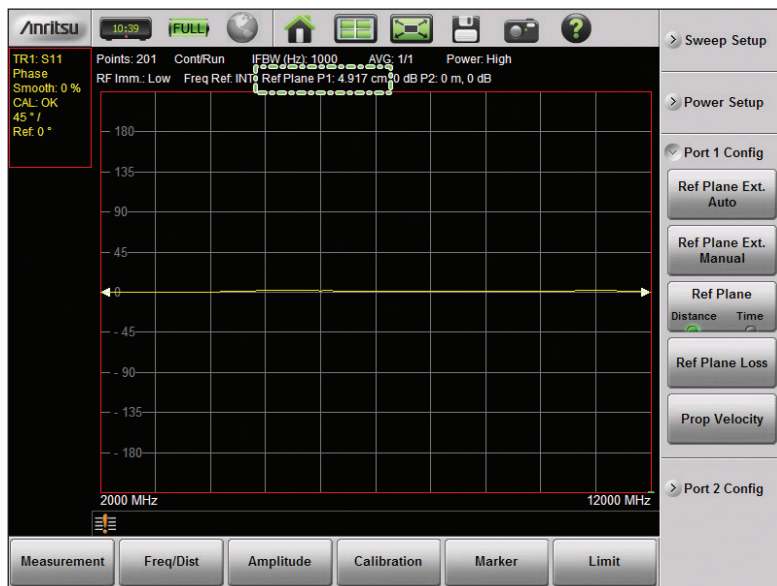

After 1-button Automatic Reference Plane Extension

Microwave Site Master S820E Cable & Antenna Analyzer Available Options



Vector Network Analyzer (Option 440)

Numerous Trace Graph Types Available in VNA Mode

Complex VNA measurements can be presented to the user in many different forms. The Site Master S820E has 12 of the most common VNA graph types, so you shouldn't have any situations where the desired graph format is not available. Each trace can be individually configured to meet your needs.

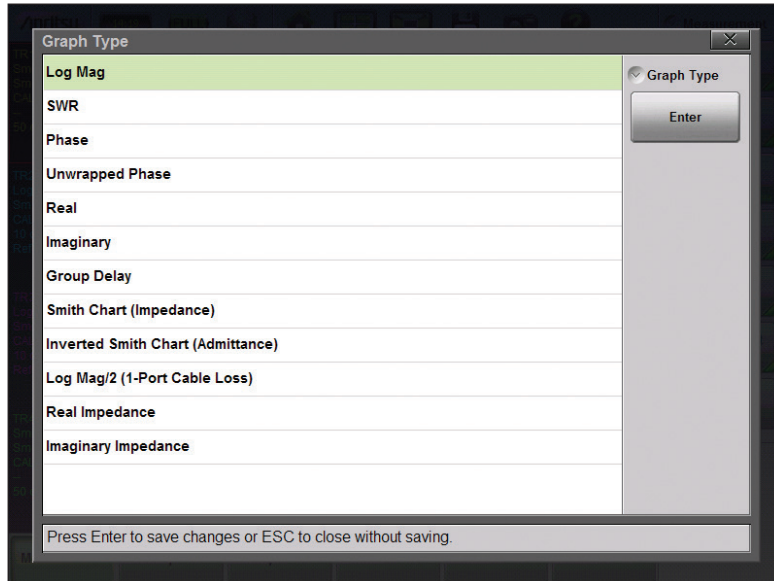

12 of the most common VNA graph types are readily available to apply to any trace

Numerous File Types for Compatibility with External Software Tools

VNA measurement files are often used with simulation software, materials measurement software and so on. To help ensure compatibility with a wide array of post processing software tools, the Site Master S820E offers numerous options for saving files. Simply select the file format that suits your needs and that's it.

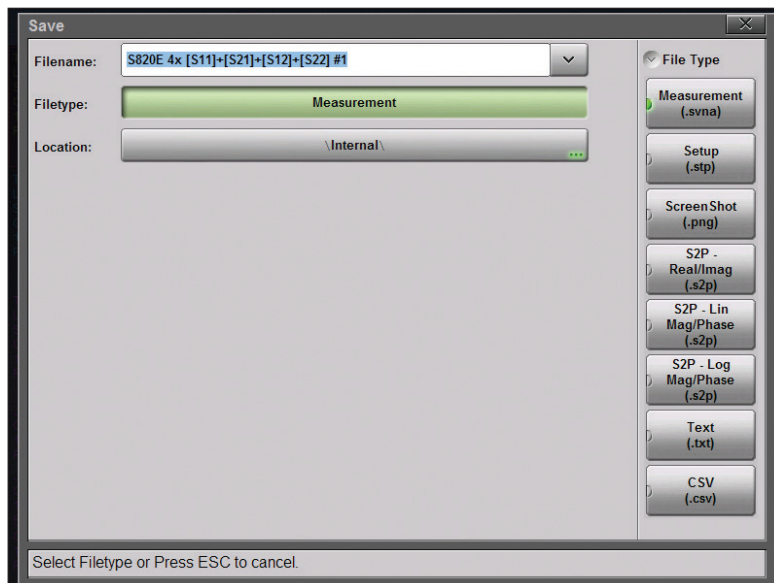

Select from numerous file formats in VNA Mode for easy use with external software packages

Microwave Site Master S820E Cable & Antenna Analyzer Available Options



Vector Network Analyzer (Option 440)

Convenient Through Update Feature for Removing the Transmission Measurement Drift Effects of External Cables

The Site Master S820Es Active Thermal Management minimizes instrument drift caused by temperature changes. External cables used are now the largest cause of transmission measurement drift. This instrument has a convenient Through Update feature that allows these drift effects to be easily removed without having to repeat a full 2-port calibration. An excellent time-saving feature that maximizes your accuracy and productivity.

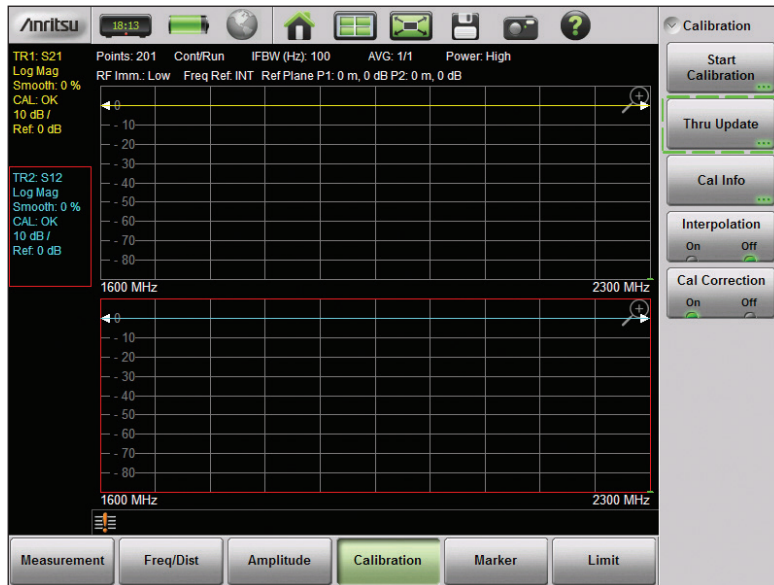

With a simple Through Update, measurement errors caused by the external cable drift is removed

Flexible Display Configuration with Easy Overlaid Measurements

Many users prefer to have several measurement traces overlaid on a single graph as opposed to showing multiple graphs. Filters are a good example. Overlaying S11 (Return Loss), and S21 (Insertion Loss) & S21 (Group Delay) is easily done with a configurable display.

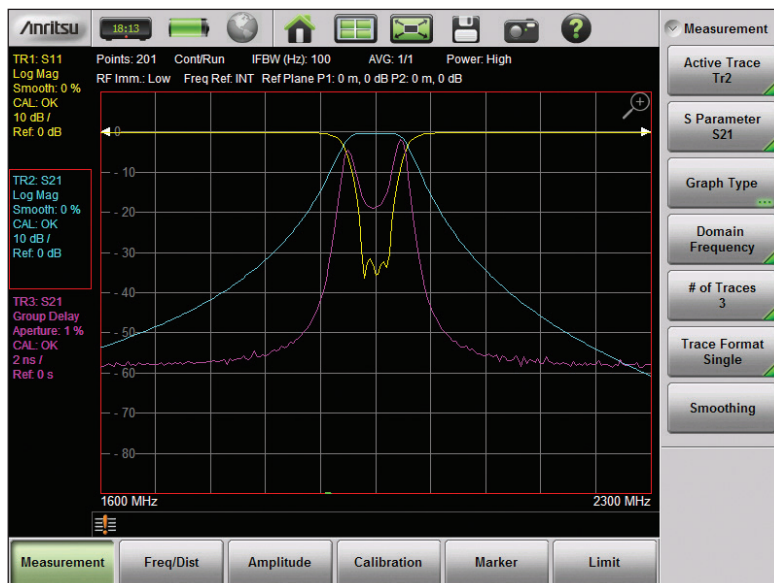

Filter measurement with S11 (Return Loss), S21 (Insertion Loss) and S21 (Group Delay) shown



Vector Voltmeter (Option 441)

Full-function Vector Voltmeter Option

The Site Master S820E Vector Voltmeter option provides full capabilities including A/B and B/A ratio measurements. The A/B and B/A Ratio measurement functionality does not require any additional VNA options, unlike some competitive products in the market.

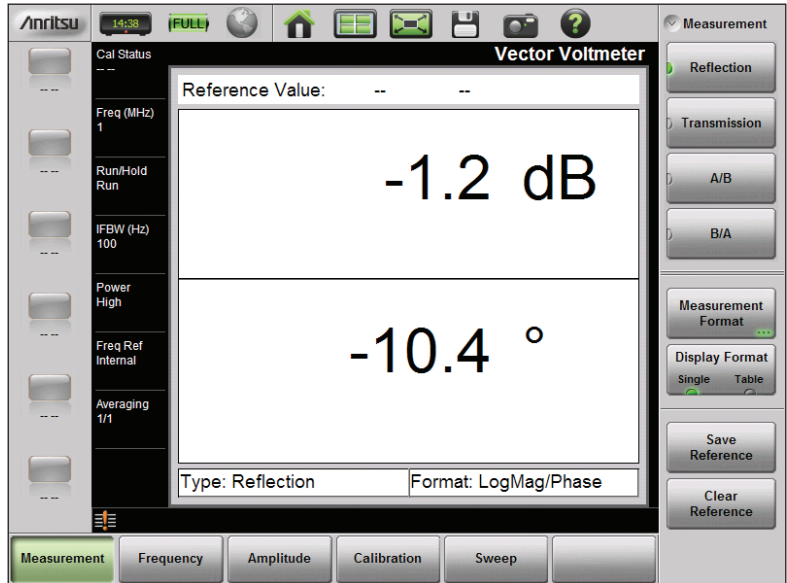

Full Vector Voltmeter A/B or B/A ratio capability without needing additional VNA mode options

Measure and Match Multiple Cables (Up to 12 Plus 1 Reference) or DUTs With Ease Using the Standard Table Display

Often there are cases where multiple cables need to be matched to some specified tolerance for the system to deliver its intended performance. Using the standard Table display format, the Site Master S820E Vector Voltmeter option simplifies this task and saves valuable time in the field.

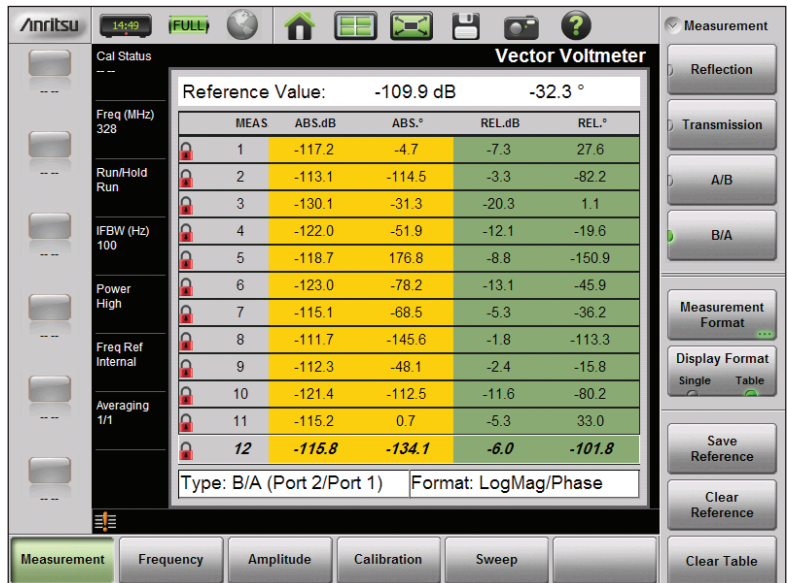

Easily phase match multiple cables with the standard table display feature

Microwave Site Master S820E Cable & Antenna Analyzer Available Options



Vector Voltmeter (Option 441)

Unique, Time-saving Auto-Tune Input for A/B and B/A Ratio Function

Other Vector Voltmeter instruments require a 10 MHz reference between the Vector Voltmeter and the external source, otherwise the reference input signal may not be seen due to absolute frequency errors of the instruments. The Site Master S820E has a unique, automatic Auto-Tune feature that allows the instrument to lock itself to the reference input signal even if the absolute frequency error is beyond the measurement bandwidth.

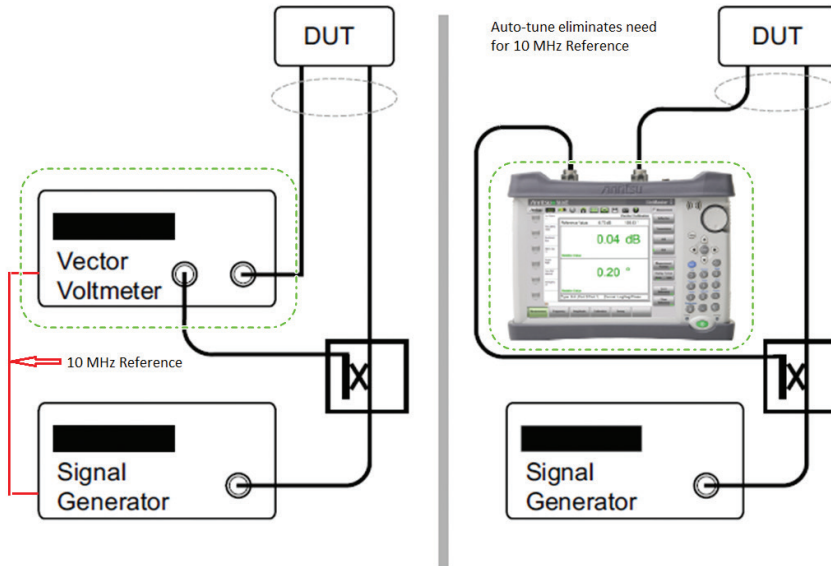

Vector Voltmeter on left requires 10 MHz reference. The Auto-Tune feature eliminates this requirement

Flexible Data Display Format For Ease of Comparison and Compatibility with Other Data Formats

Most modern Vector Voltmeter options only offer one data display type during operation — log magnitude and phase. The Site Master S820E offers both of these as well as three other data display types to suit the user's needs or preferences. Switching between display types is fast and easy.

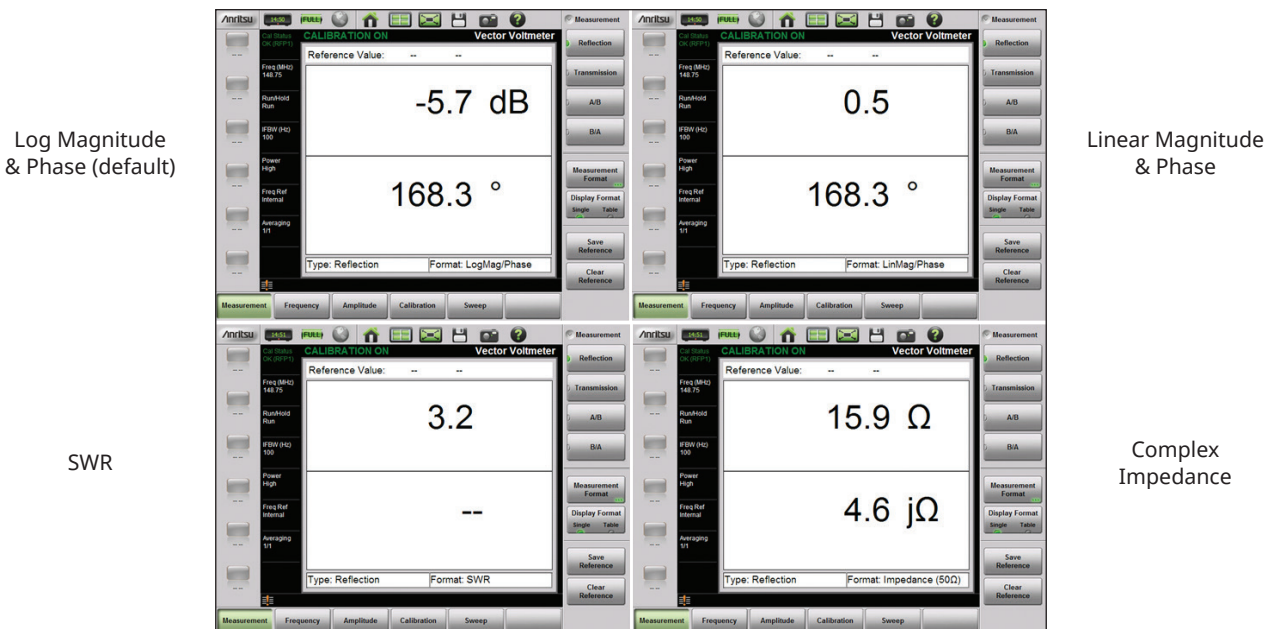

Select which data display format you prefer, the Site Master S820E converts format automatically

Microwave Site Master S820E Cable & Antenna Analyzer Information

Physical Information

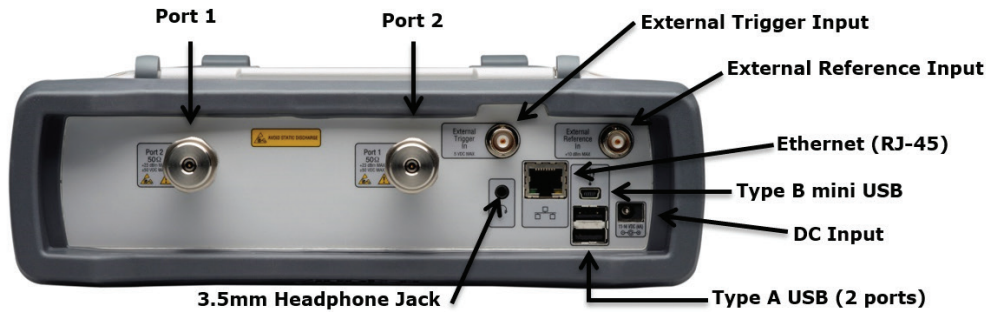

All connectors are conveniently located on the top panel, leaving the sides clear for handheld use

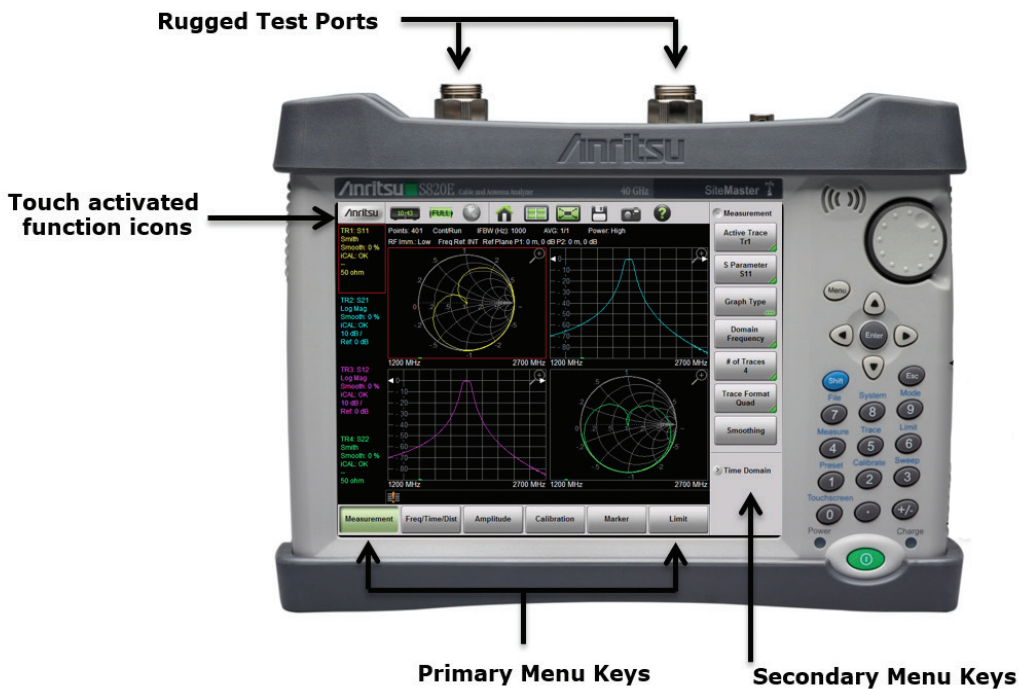

Microwave Site Master S820E Cable & Antenna Analyzer Ordering Information

Ordering Information (standard configuration)



Part Number	Description
S820E	Microwave Site Master (Requires one frequency option: 708, 714, 720, 730, or 740) Three Year Warranty (One year on battery)

Frequency Options (select one frequency option only)

Option Number	Description
S820E-0708	1 MHz to 8 GHz, type N(f) ports
S820E-0714	1 MHz to 14 GHz, type N(f) ports
S820E-0720	1 MHz to 20 GHz, type Ruggedized K(m) ports (compatible with 3.5 mm and SMA connectors)
S820E-0730	1 MHz to 30 GHz, type Ruggedized K(m) ports (compatible with 3.5 mm and SMA connectors)
S820E-0740	1 MHz to 40 GHz, type Ruggedized K(m) ports (compatible with 3.5 mm and SMA connectors)

Instrument Options



Option Number	Description
S820E-0440	Vector Network Analyzer (VNA)
S820E-0441	Vector Voltmeter (VVM)
S820E-0098	Standard Calibration to ISO/IEC 17025:2005
S820E-0099	Premium Calibration to ISO/IEC 17025:2005 plus Test Data

Standard Accessories (included with instrument)



Part Number	Description
2000-1654-R	Soft Carrying Case
71693-R	Ruggedized K(f) to N(f), 2 pcs (included only with S820E-0720)
633-75	Rechargeable Li-Ion Battery
40-187-R	AC-DC Adapter
806-141-R	Automotive Power Adapter, 12 VDC, 60 W
2000-1691-R	Stylus with Coiled Tether
2000-1797-R	Screen Protector Film (one factory installed, one spare)
3-2000-1498	USB A/5-pin Mini-B Cable, 3.05 m (10 ft)
2000-1371-R	Ethernet Cable, 2.13 m (7 ft) Certificate of Calibration and Conformance

Documentation (available at www.anritsu.com)

Part Number	Description
11410-00749	Technical Data Sheet
10580-00343	User Guide
10580-00344	Programming Manual
10580-00345	Maintenance Manual