

Technical Specification



Frequency Range(GHz)	0.8 – 8.0
Gain(dBi)	10 Typ.
Polarization	Linear
3dB Beamwidth(deg)	E Plane: 26 - 110
	H Plane: 24 - 67
Cross Pol. Isolation(dB)	30 Typ.
VSWR	1.5:1 Typ.
Connector	N-Female or SMA-Female
Power Handling(W CW)	N-Female: 300 Max.
	SMA-Female: 50 Max.
Material	Al
Size(mm)	284 x 183 x 252
Net Weight(Kg)	2.1 Around

PATENT ID (China)

ZL201630454657.5

Outline Drawing (Size: mm)

N-Female Output (P/N: LB-880-NF)

For SMA-Female output outline drawing, please contact A-INFO.

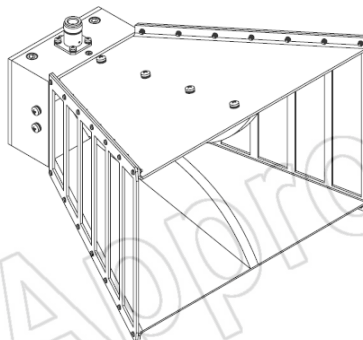
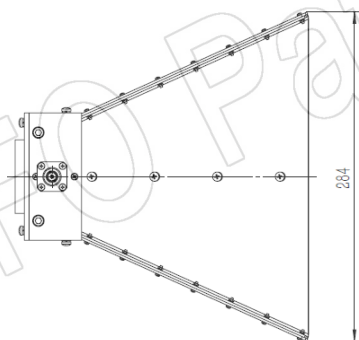
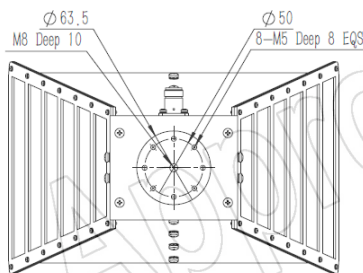
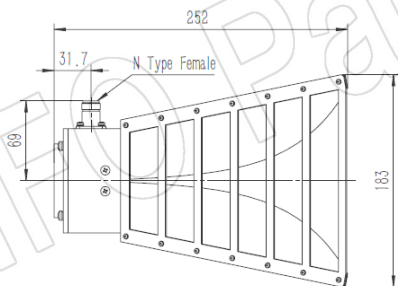

AINFO Inc.

China(Beijing):
China(Chengdu):
USA :

Tel: (+86) 10-6266-7326,
Tel: (+86) 28-8519-2786,
Tel: (+1) 949-639-9688,

(+86) 10-6266-7327
(+86) 28-8519-3044
(+1) 949-639-9608

Fax: (+86) 10-6266-7379
Fax: (+86) 28-8519-3068
Fax: (+1) 949-639-9670

Website: www.ainfoinc.com
Email: sales@ainfoinc.com

N-Female Output with L Type Mounting Bracket (Option, P/N: LB-10180-L)

For SMA-Female output outline drawing, please contact A-INFO.

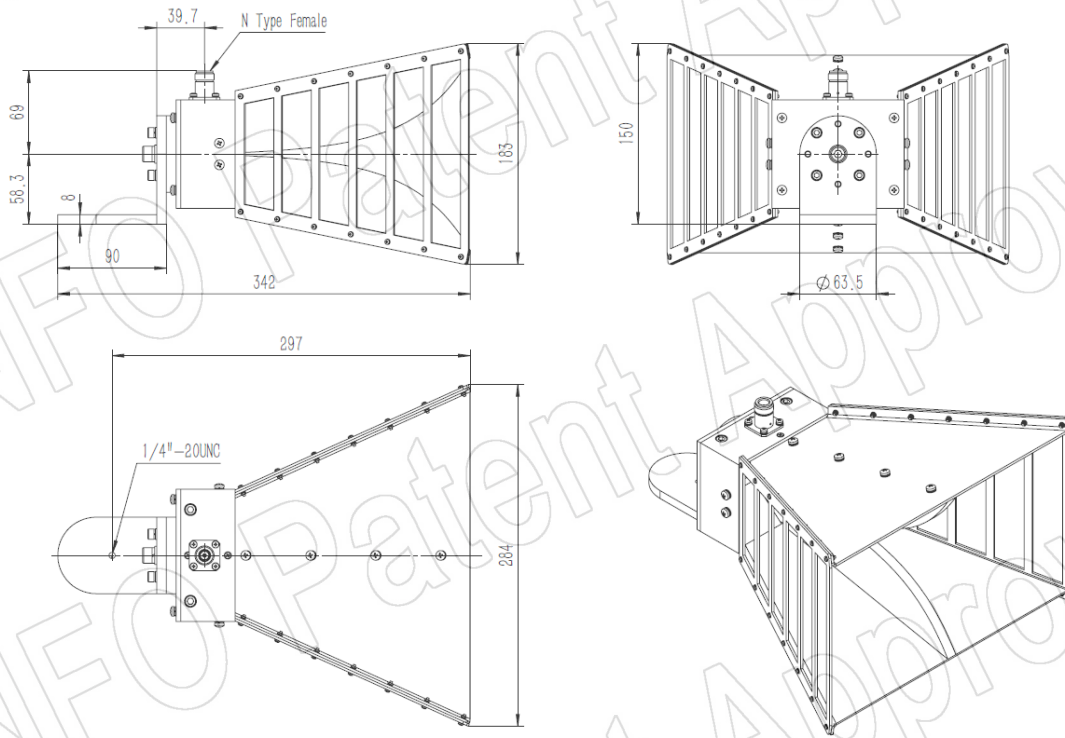

N-Female Output with Radome (Option, P/N: LB-880-NFSPO, Outdoor Application)

For SMA-Female output outline drawing, please contact A-INFO.

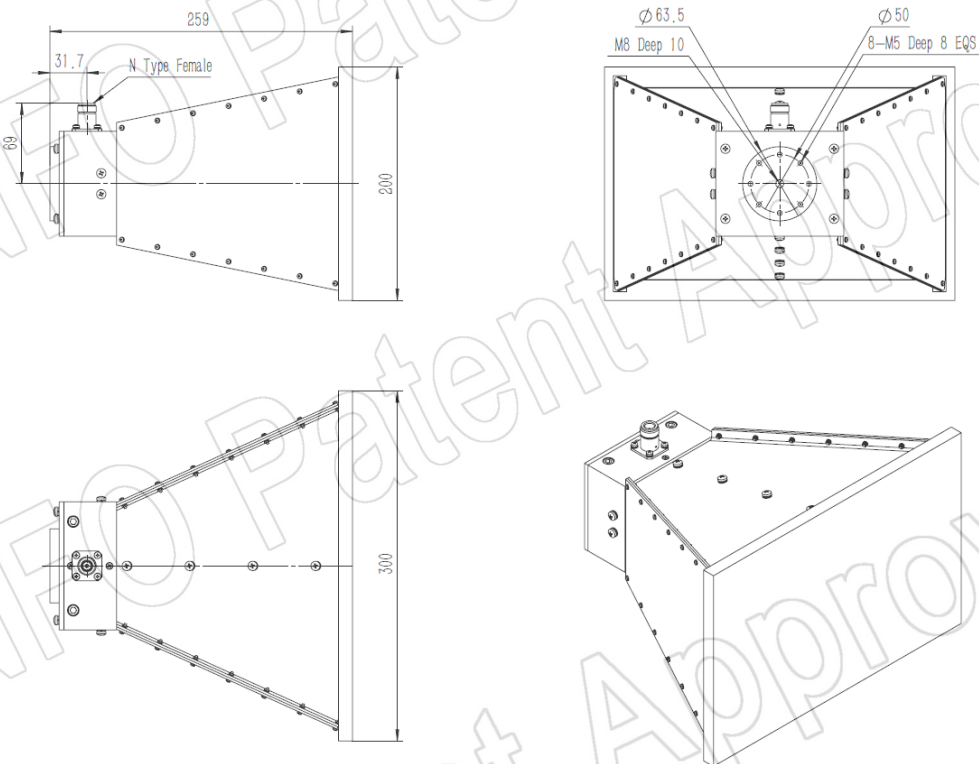

N-Female Output with L Type Mounting Bracket and Radome (Option, P/N: LB-10180-L & LB-880-NFSPO, Outdoor Application)

For SMA-Female output outline drawing, please contact A-INFO.

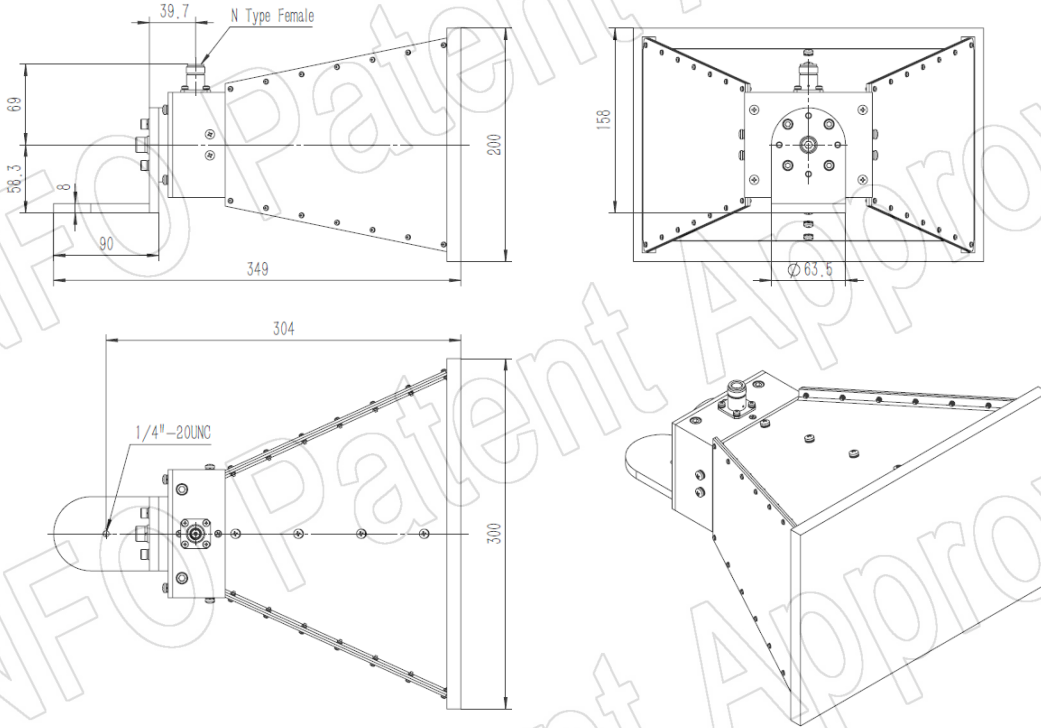

Test Results

1. Gain & Antenna Factor

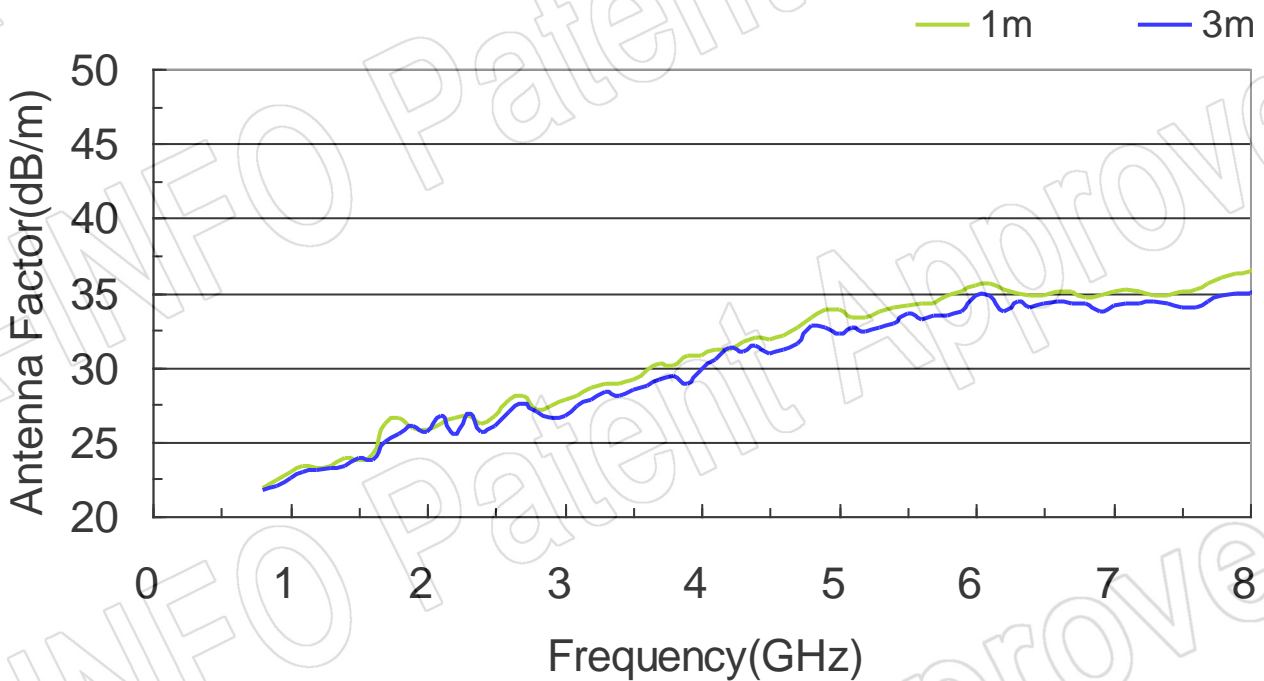
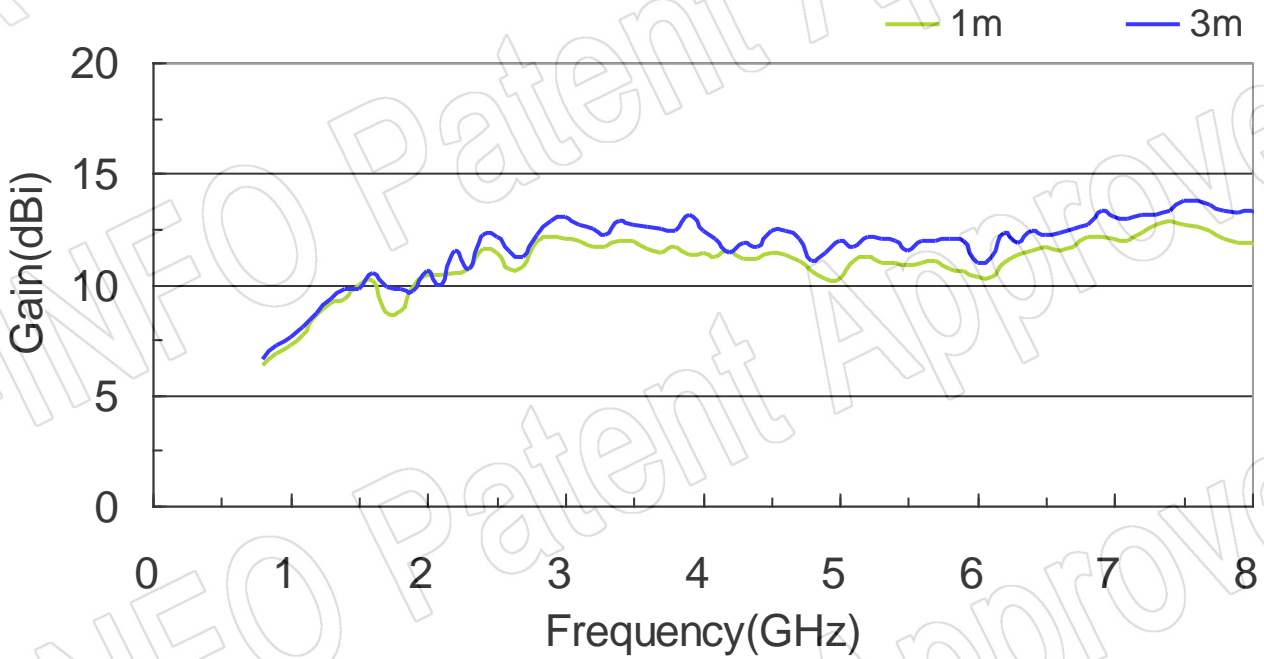

2. Cross Polarization Isolation

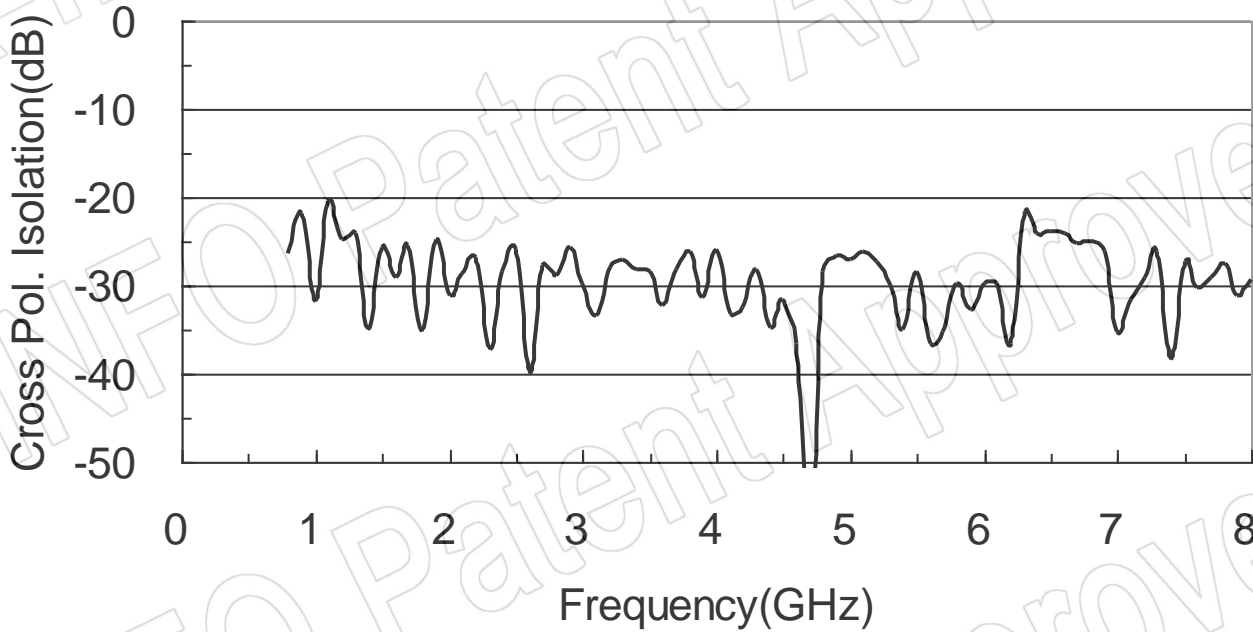

3. VSWR

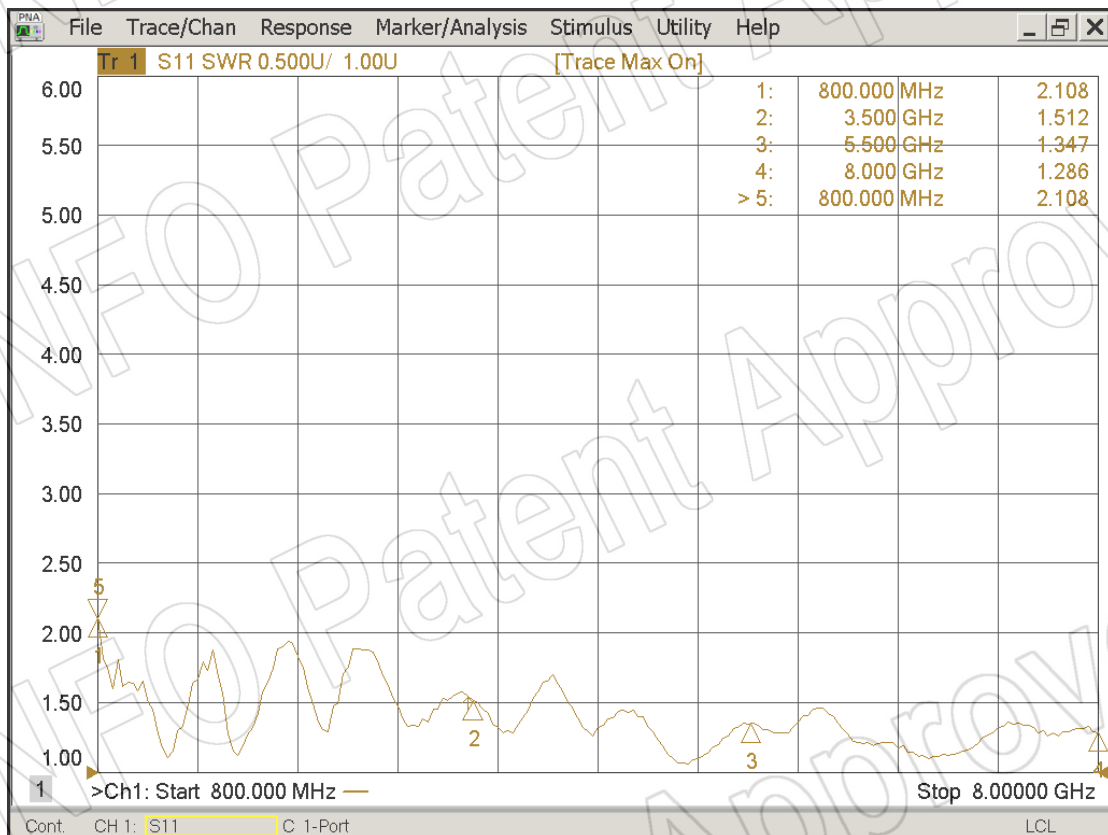

4. Pattern

