



VN8900 Interface Family Manual

Version 6.7 | English

Imprint

Vector Informatik GmbH
Ingersheimer Straße 24
D-70499 Stuttgart

The information and data given in this user manual can be changed without prior notice. No part of this manual may be reproduced in any form or by any means without the written permission of the publisher, regardless of which method or which instruments, electronic or mechanical, are used. All technical information, drafts, etc. are liable to law of copyright protection.

© Copyright 2023, Vector Informatik GmbH. All rights reserved.

Contents

1 Introduction	5
1.1 About this User Manual	6
1.1.1 Warranty	7
1.1.2 Registered Trademarks	7
1.2 Important Notes	8
2 VN8900 Interface Family	9
2.1 System Description	10
2.1.1 Introduction	10
2.1.2 Real Time Processing	12
2.1.3 Stand-Alone Mode	12
2.1.4 Network Extension	13
2.2 Base Modules	14
2.2.1 VN8911 Base Module	14
2.2.2 VN8914 Base Module	20
2.2.3 VN8912 / VN8912A Base Module	26
2.3 Plug-in Modules	31
2.3.1 VN8970 FlexRay/CAN/LIN Module	31
2.3.2 VN8972 FlexRay/CAN/LIN Module	43
2.4 Accessories	55
2.5 Mounting of Plug-in Modules and Piggybacks	56
3 Getting Started	59
3.1 Driver Installation	60
3.1.1 General Information	60
3.1.2 Installation Instructions	60
3.2 Vector Hardware Manager	63
3.2.1 Hardware Configuration	63
3.2.2 Tool Location and Help	63
3.3 Loop Tests	64
3.3.1 CAN	65
3.3.2 FlexRay	67
4 Time Synchronization	68
4.1 General Information	69
4.2 Software Sync	71
4.2.1 General Information	71

4.3 Hardware Sync	72
4.3.1 General Information	72
4.3.2 Configuration	73
5 Important Notes - Details	74
5.1 Safety Instructions and Hazard Warnings	75
5.1.1 Proper Use and Intended Purpose	75
5.1.2 Hazards	76
5.2 Disclaimer	77
5.3 Licenses	78
5.3.1 GRUB Version 0.4.4-r61	78
5.3.2 AutoLaunch V310	78
5.4 Disposal of Vector Hardware	79
6 Wichtige Hinweise	80
6.1 Sicherheits- und Gefahrenhinweise	81
6.1.1 Sach- und bestimmungsgemäßer Gebrauch	81
6.1.2 Gefahren	82
6.2 Haftungsausschluss	83
6.3 Lizenzen	84
6.3.1 GRUB Version 0.4.4-r61	84
6.3.2 AutoLaunch V310	84
6.4 Entsorgung von Vector Hardware	85

1 Introduction

In this chapter you find the following information:









1.1 About this User Manual	6
1.1.1 Warranty	7
1.1.2 Registered Trademarks	7
1.2 Important Notes	8

1.1 About this User Manual

Conventions

In the two following charts you will find the conventions used in the user manual regarding utilized spellings and symbols.

Style	Utilization
bold	Blocks, surface elements, window- and dialog names of the software. Accentuation of warnings and advices. [OK] Push buttons in brackets File Save Notation for menus and menu entries
Source Code	File name and source code.
Hyperlink	Hyperlinks and references.
<CTRL>+<S>	Notation for shortcuts.

Symbol	Utilization
	This symbol calls your attention to warnings.
	Warning of damages by electrostatic discharge (ESD = Electrostatically Sensitive Device).
	Warning of hot surface! Do not touch without appropriate precautions.
	Here you can obtain supplemental information.
	Here you can find additional information.
	Here is an example that has been prepared for you.
	Step-by-step instructions provide assistance at these points.
	Instructions on editing files are found at these points.
	This symbol warns you not to edit the specified file.

1.1.1 Warranty

Restriction of warranty

We reserve the right to change the contents of the documentation and the software without notice. Vector Informatik GmbH assumes no liability for correct contents or damages which are resulted from the usage of the documentation. We are grateful for references to mistakes or for suggestions for improvement to be able to offer you even more efficient products in the future.

1.1.2 Registered Trademarks

Registered trademarks

All trademarks mentioned in this documentation and if necessary third party registered are absolutely subject to the conditions of each valid label right and the rights of particular registered proprietor. All trademarks, trade names or company names are or can be trademarks or registered trademarks of their particular proprietors. All rights which are not expressly allowed are reserved. If an explicit label of trademarks, which are used in this documentation, fails, should not mean that a name is free of third party rights.

- ▶ Windows, Windows 7, Windows 8.1, Windows 10, Windows 11 are trademarks of the Microsoft Corporation.

- ▶  and  are trademarks of the SD Card Association.

1.2 Important Notes

**Caution!**

We provide our important notes and safety instructions in several languages, including English (EN) and German (DE). For more details, see the relevant section:

- ▶ EN: [Important Notes - Details](#)
- ▶ DE: [Wichtige Hinweise](#)

2 VN8900 Interface Family

In this chapter you find the following information:

2.1 System Description	10
2.1.1 Introduction	10
2.1.2 Real Time Processing	12
2.1.3 Stand-Alone Mode	12
2.1.4 Network Extension	13
2.2 Base Modules	14
2.2.1 VN8911 Base Module	14
2.2.2 VN8914 Base Module	20
2.2.3 VN8912 / VN8912A Base Module	26
2.3 Plug-in Modules	31
2.3.1 VN8970 FlexRay/CAN/LIN Module	31
2.3.2 VN8972 FlexRay/CAN/LIN Module	43
2.4 Accessories	55
2.5 Mounting of Plug-in Modules and Piggybacks	56

2.1 System Description

2.1.1 Introduction

Network interface with real-time computer

The VN8900 interface family is designed for high-performance applications in combination with CANoe/CANalyzer. The application areas include system simulations or bypassing applications with Simulink, remaining bus simulations, gateway implementations, test executions (MiniHIL) or data monitoring.

Another key feature is the execution of time-critical CANoe/CANalyzer configurations without any user PC and without any negative effects on functionality of the running application.

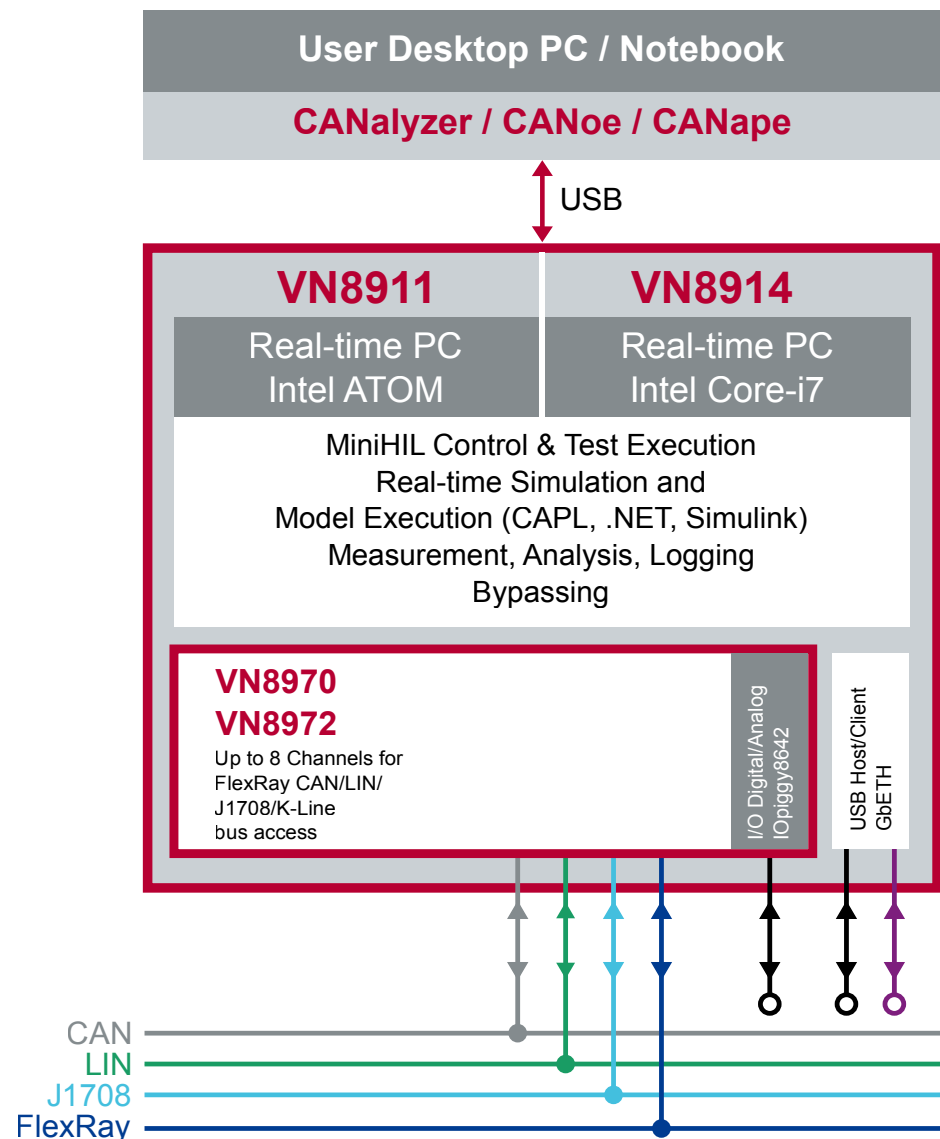

Figure 1: Operator side (user PC) and measurement side

Hardware flexibility

Another important VN8900 product characteristic is the modularity of the network interface, which lets users flexibly adapt it to the measurement environment and existing buses. The overall system is comprised of these components:

▶ **Base Module**

Processor unit with memory for executing simulations and time-critical program sections in stand-alone mode. The Base Module has an Intel processor and basic port connections for power supply, synchronization, USB and Ethernet. You will find further details on Base Modules beginning on page 14.



Figure 2: VN8914 back side

▶ **Plug-in Module**

The plug-in module represents the actual network interface; it provides the related interfaces as plug connections (e. g. FlexRay, CAN, LIN or digital-analog in-put/output). You will find additional details on plug-in modules beginning on page 31.



Figure 3: VN8914 with inserted VN8972 FlexRay/CAN/LIN Module



Caution!

Please note that some functions on the device (e. g. control of the LEDs via CAPL, key pads or power up/down control) are not or not fully available if it is operated without a plug-in module (see section [Plug-in Modules](#) on page 31). We therefore recommend always operating it with a plug-in module, if these features are required.

► Piggybacks

Piggybacks establish the connection from the Vector network interface to the user's electrical networks via appropriate transceivers (FlexRay/CAN/LIN...). Moreover, the Piggyback usually offers the electrical isolation to protect the measurement hardware as well as the system under test.

The amount and kind of supported Piggybacks varies between the plug-in modules. A list of compatible Piggybacks can be found in the [accessories manual](#) or on our [website](#).

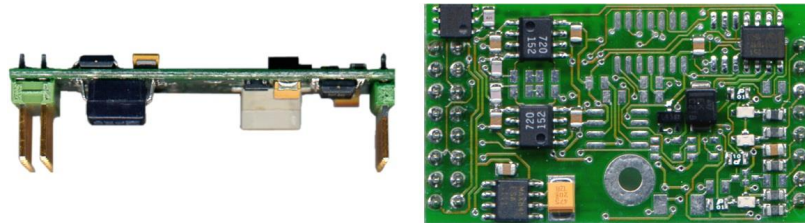

Figure 4: Piggyback

2.1.2 Real Time Processing

General

When requirements for timing precision are strict, the measurement hardware must be able to operate with very low latency. The integrated processor of the VN8900 interface family meets this standard and offers significantly improved latency times compared to normal PCs.

CANoe

The VN8900 interface family is a real-time hardware that is designed for using with CANoe. CANoe offers the option of executing real-time relevant simulations and test functions on the VN8900 – separate from the graphic user interface. On the one hand, this increases overall system performance, and on the other it enables shorter latency times and more precise timers. Configuration of the simulation and evaluation are performed on a standard PC (CANoe), while the simulation and test kernel are executed on the VN8900 (CANoeRT). Communication between the two computers is routed via a USB cable or via Ethernet (see figure 1).

2.1.3 Stand-Alone Mode

CANoe configuration The VN8900 interface family offers a stand-alone mode which allows a measurement without any additional user PC.

For this purpose a measurement application can be configured in CANoe, which is then written into the permanent memory of the VN8900. After a restart, the configuration is loaded and the measurement autonomously started.

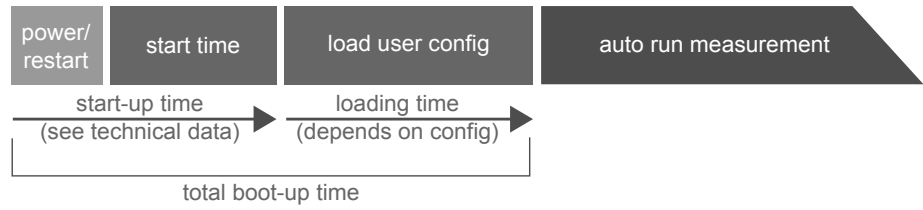

Figure 5: Booting overview

2.1.4 Network Extension

Additional network channels

CANoe/CANalyzer supports a single Base Module at a time. To use more network channels, the VN8900 interfaces offer additional USB (host) ports to connect to other Vector network interfaces. Time synchronization of the different network interfaces can be done via the sync line.

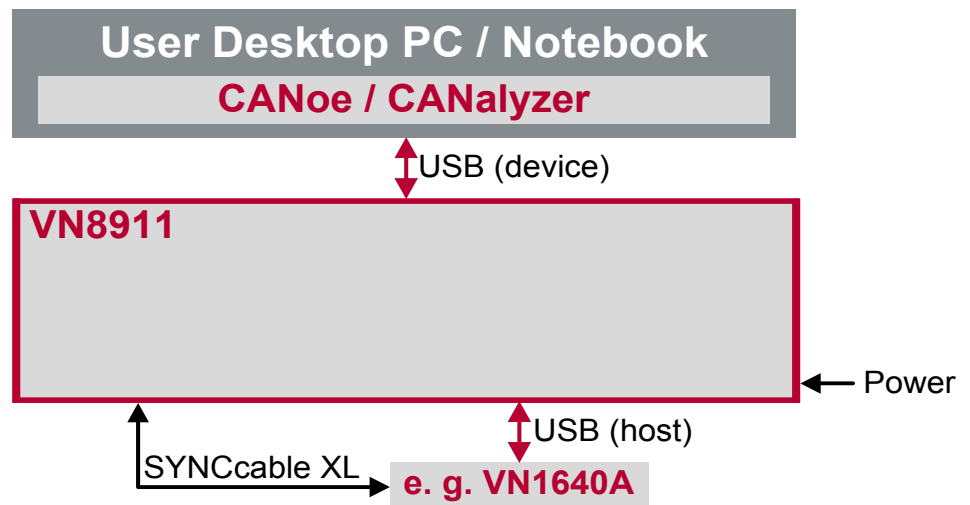

Figure 6: Extension example

2.2 Base Modules

2.2.1 VN8911 Base Module

Description

Base Module with integrated Intel Atom processor unit for running real-time applications. Connection to user networks is provided by a plug-in module with individual bus transceivers (see section [Plug-in Modules](#) on page 31).

The VN8911 also supports the Vector Tool Platform (VTP). With Extended Real Time as a part of the Vector Tool Platform, the throughput, latency, and determinism of CANoe and CANape are improved. To achieve this, the device is logically divided into two areas. A new area provides Extended Real Time in which predefined functions can be executed under real-time conditions.

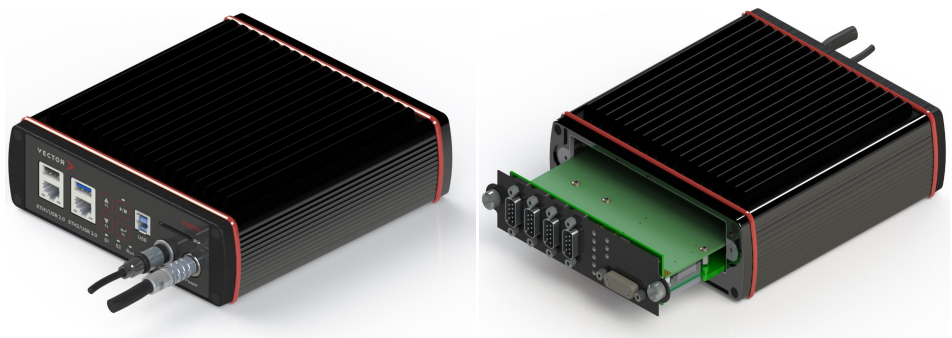

Figure 7: VN8911 back and front side (with plug-in module)



Caution!

Please note that some functions on the device (e. g. control of the LEDs via CAPL, key pads or power up/down control) are not or not fully available if it is operated without a plug-in module (see section [Plug-in Modules](#) on page 31). We therefore recommend always operating it with a plug-in module, if these features are required.

Connections



Figure 8: VN8911 back side

- ▶ **Keypad Start/Stop**
This key instantly starts or stops a preconfigured CANoe measurement.
- ▶ **Keypads F2/F3/F4**
These keys can be assigned to CAPL functions.

▶ **LED S1/S2**

These LEDs offer a visual feedback for active measurements and can be individually controlled via CAPL.

▶ **LED Run**

Multicolored channel LED which indicates the power up/down status.

Color	Description
Off	Power up/down control line not activated since reboot.
Green	Device is running.
Red	Inactive power up/down control line. Device shuts down into power-down mode after time out (has to be defined in CANoe).

▶ **LED Power**

Multicolored channel LED which indicates the power status.

Color	Description
Off	Power supply disconnected.
Green	Power supply connected.

▶ **ETH1/ETH2**

These Ethernet ports can be used to connect other Vector Ethernet devices for use with CANoe, CANalyzer or CANape. Currently supported: VX1121, VX1131, VX1132, VX1135, VX1060. Furthermore, the Ethernet ports can be used to interconnect your host PC and the VN8911 to use them with measurement applications (e. g. CANoe, CANalyzer).

▶ **USB 2.0/3.0 (host)**

These USB ports can be used to connect other Vector USB devices for use with CANoe or CANalyzer. The summarized output current at these ports is limited to **1050 mA**. A list of supported devices can be found on our [website](#).

**Note**

When using the USB host connector, the Vector device has to be connected to the VN8911 before powering the VN8911. Please ensure that the USB logo on the USB cable is on the bottom side (USB pins at top) before connecting. Do not force the cable into the USB connector to avoid mechanical damages.

▶ **USB (device)**

Interconnect your Host PC and the VN8911 via this USB 3.0 port to install the device on the Host PC and to use it together with measurement applications (e. g. CANoe, CANalyzer).

▶ **SD card slot**

This slot can be used for recording use cases.

Recommended cards: Industrial Grade SD, SDHC or SDXC.

► **Sync/Ctrl**

This terminal (Binder type 711) can be used for time synchronization of different Vector devices (see section **Time Synchronization** on page 68) or to control the power up/down function of the device.

Pin	Assignment
1	Power up/down control line
2	Synchronization line
3	Ground

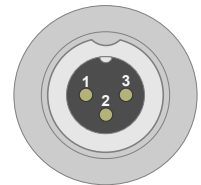

Caution!

The power up/down control line uses the same reference to GND as the power supply input of the device, not pin 3 of the sync/ctrl connector.

In order to use the power up/down function, switch off the device and remove the plug-in module. Find the power up/down switch underneath the heat sink and set it to **ON**.

Power up/down switch

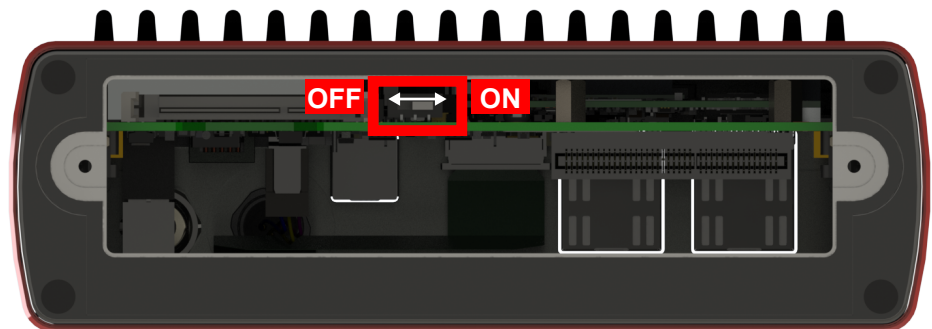

Figure 9: Power up/down switch in VN8911

Reassemble the plug-in module and connect the power supply. Depending on the voltage at the power up/down control line, the VN8911 can be powered up or shut down.

Ctrl	Description
0 V	If running, the device shuts down after time out (approx. 5 seconds). Otherwise the device remains in power-up mode.
> 5 V	If in power-down mode, the device powers up (please note the start-up time in section Technical data on page 19). Current consumption in power-down mode: 2.9 mA, max. 104 mW @ 36 V.



Example

With this wiring, the VN8911 powers up and down with the ignition switch of the vehicle.

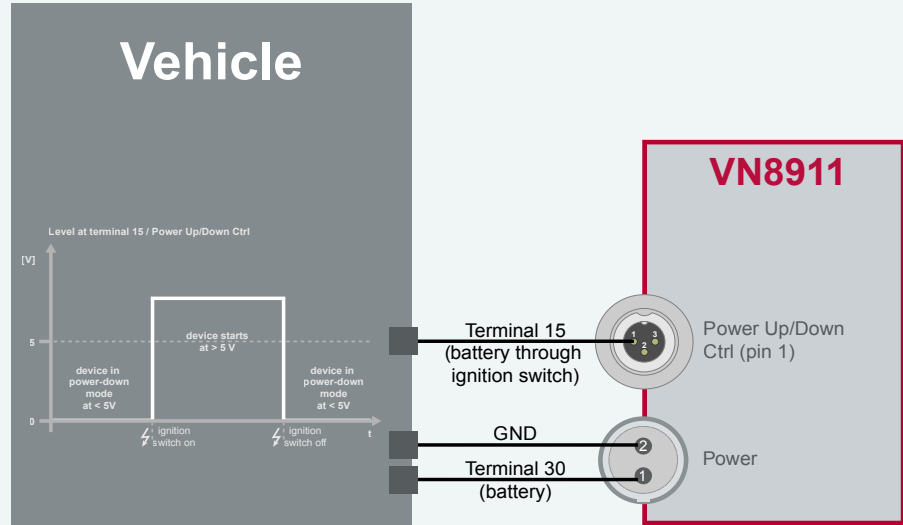

You can use the following Vector accessories to connect the VN8911 to the vehicle:

- ▶ **Power up/down control**
Connection Cable Binder Type 711 (3-pin), part number 30011
- ▶ **Power**
ODU Connector / Bunch Plugs, part number 05069

- ▶ **Power**
For its power supply, the VN8911 has a two-pin ODU connector (MINI-SNAP size 1, type GG1L0C-P02RP00-0000). Attach the enclosed power cable to power up the unit (matching ODU connector type S11L0C-P02NPL0-6200).

Pin	Assignment
2	GND
1	+



CFast card

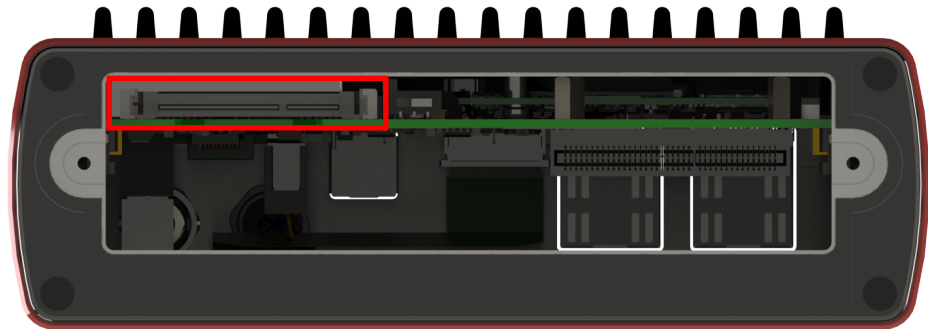

Figure 10: CFast card slot in VN8911

The VN8911 operating system is stored on a CFast card and must not be removed during operation.

**Note**

The CFast card should only be removed for system recoveries. Please contact the Vector support for further instructions on system recoveries.

Technical data
 VN8911

Processor	Intel ATOM E3845 Quad-Core with 1.91 GHz
Memory	4 GB
Hard drive	CFast card, 16 GB
Transceiver	Depends on the plug-in module and its Piggybacks
PC interface	USB 3.0 SuperSpeed
Temperature range	Operating: -40 °C...+60 °C Shipping and storage: -40 °C...+85 °C
Relative humidity of ambient air	15 %...95 %, non-condensing
USB 1/2 output current	Max. 1050 mA, both ports combined
External power supply	6 V...36 V DC Power-up: 9 V DC
Power consumption	Typ. 7.0 W without plug-in module
Start-up time	Approx. 30 seconds
Dimensions (LxWxH)	190 mm x 170 mm x 60 mm (with plug-in module)
Operating system requirements	Windows 10 (x64, 64 bit) Windows 11 (x64, 64 bit)
Ethernet	1000BASE-T/100BASE-TX/10BASE-T
Supported plug-in modules	VN8970

2.2.2 VN8914 Base Module

Description

Base Module with integrated Intel Core-i7 processor unit for running real-time applications with high performance demands. Connection to user networks is provided by a plug-in module with individual bus transceivers (see section [Plug-in Modules](#) on page 31).

The VN8914 also supports the Vector Tool Platform (VTP). With Extended Real Time as a part of the Vector Tool Platform, the throughput, latency, and determinism of CANoe and CANape are improved. To achieve this, the device is logically divided into two areas. A new area provides Extended Real Time in which predefined functions can be executed under real-time conditions.



Figure 11: VN8914 front and back side (with plug-in module)



Caution!

Please note that some functions on the device (e. g. control of the LEDs via CAPL, key pads or power up/down control) are not or not fully available if it is operated without a plug-in module (see section [Plug-in Modules](#) on page 31). We therefore recommend always operating it with a plug-in module, if these features are required.

Keypads/LEDs

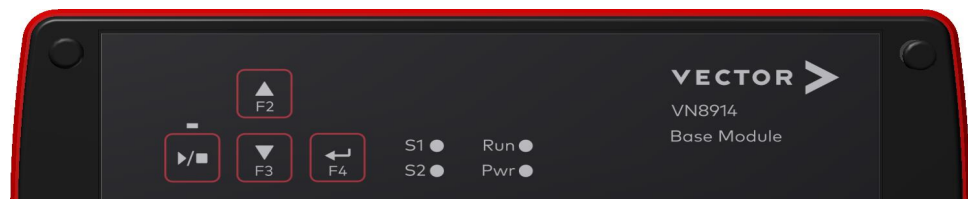

Figure 12: VN8914 front side

- ▶ **Keypad Start/Stop**
This key instantly starts or stops a preconfigured CANoe measurement.
- ▶ **Keypads F2/F3/F4**
These keys can be assigned to CAPL functions.
- ▶ **LED S1/S2**
These LEDs offer a visual feedback for active measurements and can be individually controlled via CAPL.

▶ **LED Run**

Multicolored channel LED which indicates the power up/down status.

Color	Description
Off	Power up/down control input < 5 V. Device in power down mode.
Green	Device is running (power up/down control input > 5 V).
Red	Device shuts down into power down mode after time out if power up/down feature is enabled.

▶ **LED Power**

Multicolored channel LED which indicates the power status.

Color	Description
Off	Device is not powered.
Green	Device is powered.

Connectors

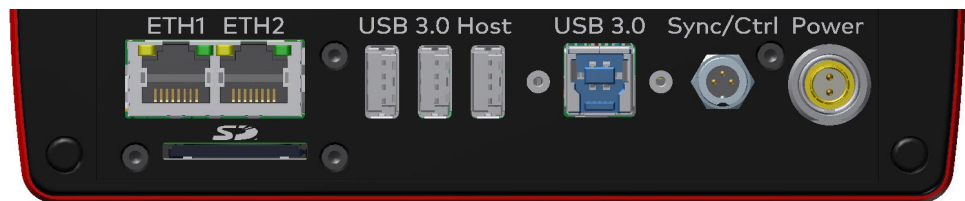

Figure 13: VN8914 back side

▶ **ETH1/ETH2**

These Ethernet ports can be used to connect other Vector Ethernet devices for use with CANoe, CANalyzer or CANape. Currently supported: VX1060, VX1121, VX1131, VX1132, VX1135. Furthermore, the Ethernet ports can be used to interconnect your host PC and the VN8914 to use them with measurement applications (e. g. CANoe, CANalyzer).

▶ **SD card slot**

This slot can be used for recording use cases.
Recommended cards: Industrial Grade SD, SDHC or SDXC.

▶ **USB 3.0 Host**

These three host ports are used to connect other Vector USB devices for use with CANoe or CANalyzer. The summarized output current at these ports is limited to **1350 mA**. A list of supported devices can be found on our [website](#).



Note

When using the USB host connector, the Vector device has to be connected to the VN8914 before powering the VN8914. Please ensure that the USB logo on the USB cable is on the bottom side (USB pins at top) before connecting. Do not force the cable into the USB connector to avoid mechanical damages.

▶ **USB 3.0**

Interconnect your Host PC and the VN8914 via this USB 3.0 port to install the device on the Host PC and to use it together with measurement applications (e. g. CANoe, CANalyzer). The USB 3.0 connector has two stand offs to securely attach the appropriate USB 3.0 cable (see accessories manual).

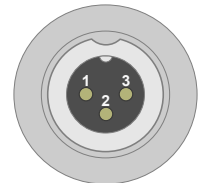

Figure 14: USB 3.0 stand offs

▶ **Sync/Ctrl**

This terminal (Binder type 711) can be used for time synchronization of different Vector devices (see section **Time Synchronization** on page 68) or to control the power up/down function of the device.

Pin	Assignment
1	Power up/down control line
2	Synchronization line
3	Ground



Caution!

The power up/down control line uses the same reference to GND as the power supply input of the device, not pin 3 of the sync/ctrl connector.

In order to use the power up/down function, switch off the device and remove the plug-in module. Find the power up/down switch underneath the heat sink and set it to **ON**.

Power up/down switch

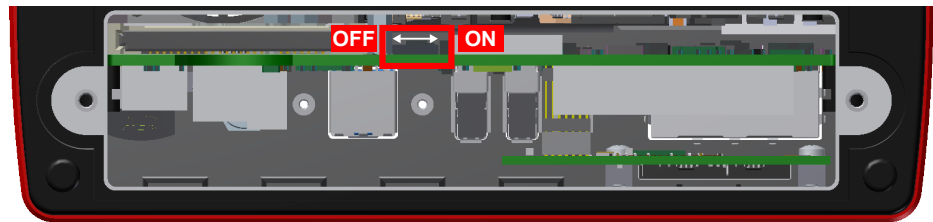

Figure 15: Power up/down switch in VN8914

Reassemble the plug-in module and connect the power supply. Depending on the voltage at the power up/down control line, the VN8914 can be powered up or shut down.

Ctrl	Description
0 V	If running, the device shuts down after time out (approx. 5 seconds). Otherwise the device remains in power-up mode.
> 5 V	If in power-down mode, the device powers up (please note the start-up time in section Technical data on page 25). Current consumption in power-down mode: 3.6 mA @ 10 V...36 V.



Example

With this wiring, the VN8914 powers up and down with the ignition switch of the vehicle.

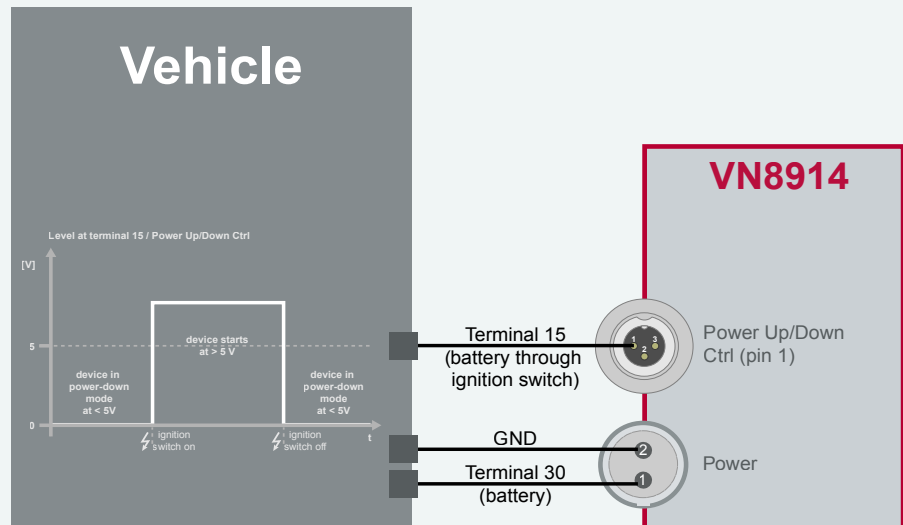

You can use the following Vector accessories to connect the VN8914 to the vehicle:

- ▶ **Power up/down control**
Connection Cable Binder Type 711 (3-pin), part number 30011
- ▶ **Power**
ODU Connector / Bunch Plugs, part number 05069

► **Power**

For its power supply, the VN8914 has a two-pin ODU connector (MINI-SNAP size 1, type GG1L0C-P02RP00-0000). Attach the enclosed power cable to power up the unit (matching ODU connector type S11L0C-P02NPL0-6200).

Pin	Assignment
2	GND
1	+



CFAST card

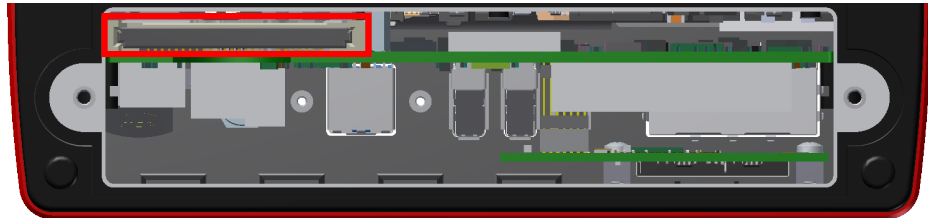

Figure 16: CFAST card slot in VN8914

The VN8914 operating system is stored on a CFAST card and must not be removed during operation.



Note

The CFAST card should only be removed for system recoveries. Please contact the Vector support for further instructions on system recoveries.



Note

Please check all fan covers of the VN8914 for impurities (e. g. dust) at regular intervals, depending on environmental conditions. For example, impurities can be removed with an appropriate vacuum cleaner.

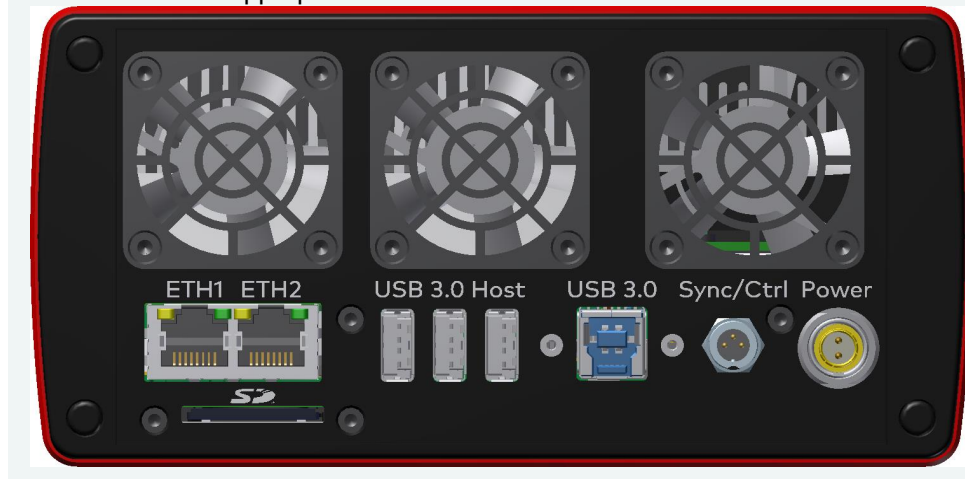

Technical data
VN8914

Processor	Intel Core-i7 6822EQ CPU
Memory	8 GB
Hard drive	CFast card, 16 GB
Transceiver	Depends on the plug-in module and its Piggybacks
Ethernet port	2x GbETH
USB host interfaces	3x USB 3.0 SuperSpeed
PC interface	USB 3.0 SuperSpeed
Temperature range	Operating: 0 °C...+50 °C Shipping and storage: -40 °C...+85 °C
Relative humidity of ambient air	15 %...95 %, non-condensing
USB 1/2/3 output current	Max. 1350 mA, all ports combined
External power supply	10 V...36 V DC
Power consumption	Typ. 18 W @ 24 V without plug-in module
Start-up time	Approx. 25 seconds
Dimensions (LxWxH)	183 mm x 172 mm x 85 mm (without plug-in module) 190 mm x 172 mm x 85 mm (with plug-in module)
Operating system requirements	Windows 10 (x64, 64 bit) Windows 11 (x64, 64 bit)
Ethernet	1000BASE-T/100BASE-TX/10BASE-T
Supported plug-in modules	VN8970, VN8972

2.2.3 VN8912 / VN8912A Base Module

Description

Base Module with integrated Intel Core-i7 processor unit for running real-time applications with high performance demands. Connection to user networks is provided by a plug-in module with individual bus transceivers (see section [Plug-in Modules](#) on page 31).

VN8912A

The main features as well as the technical data of the VN8912A are identical to the VN8912. In addition, the VN8912A also supports the Vector Tool Platform (VTP). With Extended Real Time as a part of the Vector Tool Platform, the throughput, latency, and determinism of CANoe and CANape are improved. To achieve this, the device is logically divided into two areas. A new area provides Extended Real Time in which predefined functions can be executed under real-time conditions.



Figure 17: VN8912 front side (with VN8970 plug-in module)



Caution!

Please note that some functions on the device (e. g. control of the LEDs via CAPL, key pads or power up/down control) are not or not fully available if it is operated without a plug-in module (see section [Plug-in Modules](#) on page 31). We therefore recommend always operating it with a plug-in module, if these features are required.

Front side

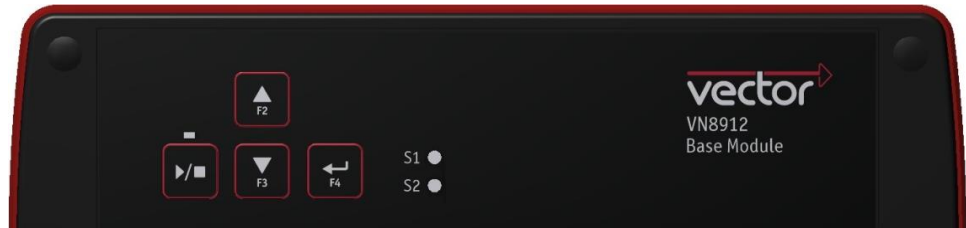

Figure 18: VN8912 front side

- ▶ **Keypad Start/Stop**
This key instantly starts or stops a preconfigured CANoe measurement.
- ▶ **Keypads F2/F3/F4**
These keys can be assigned to CAPL functions.
- ▶ **LED S1/S2**
These LEDs offer a visual feedback for active measurements and can be individually controlled via CAPL.

CFast card

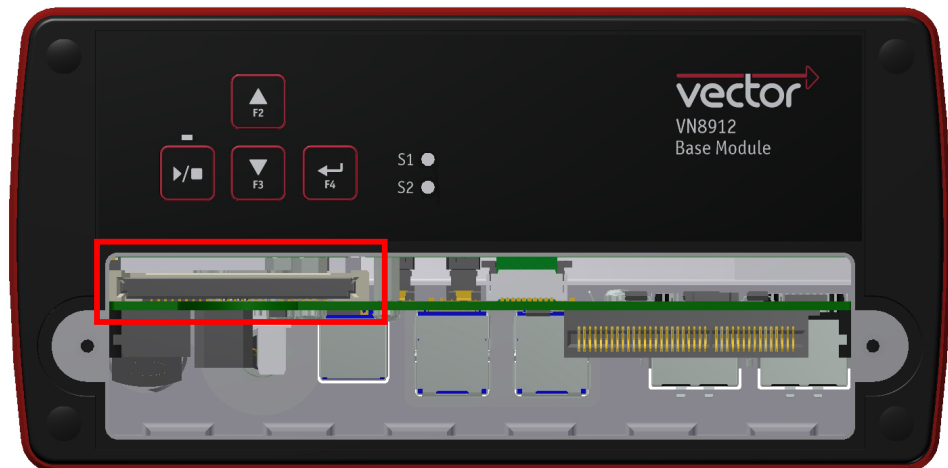

Figure 19: CFast card slot in VN8912

The VN8912 operating system is stored on a CFast card and must not be removed during operation.

**Note**

The CFast card should only be removed for system recoveries. For this purpose, a separate CFast card reader is included in the delivery. Please contact the Vector support for further instructions on system recoveries.

Back side



Figure 20: VN8912 back side

▶ **ETH 1/2**

Two independent Ethernet connections (RJ45) for Vector devices.
Currently supported: VX1060, VX1121, VX1131, VX1132, VX1135.

▶ **USB 1/2/3/4 (host)**

These four host ports are used to connect other Vector USB devices for use with CANoe or CANalyzer. The summarized output current at these ports is limited to **1350 mA**. A list of supported devices can be found on our [website](#).



Note

The Vector device has to be connected to the VN8912 before powering the VN8912.

▶ **USB (device)**

Interconnect your Host PC and the VN8912 via this USB port to install the device on the Host PC and to use it together with measurement applications (e. g. CANoe, CANalyzer).

▶ **Sync**

This terminal (Binder type 711) can be used for time synchronization of different Vector devices (see section [Time Synchronization](#) on page 68).

Pin	Assignment
1	Not connected
2	Synchronization line
3	Ground



▶ **Power**

For its power supply, the VN8912 has a two-pin ODU connector (MINI-SNAP size 1, type GG1L0C-P02RP00-0000). Attach the enclosed power cable to power up the unit (matching ODU connector type S11L0C-P02NPL0-6200).

Pin	Assignment
1	+
2	GND



**Note**

Please check all fan covers of the VN8912 for impurities (e. g. dust) at regular intervals, depending on environmental conditions. For example, impurities can be removed with an appropriate vacuum cleaner.

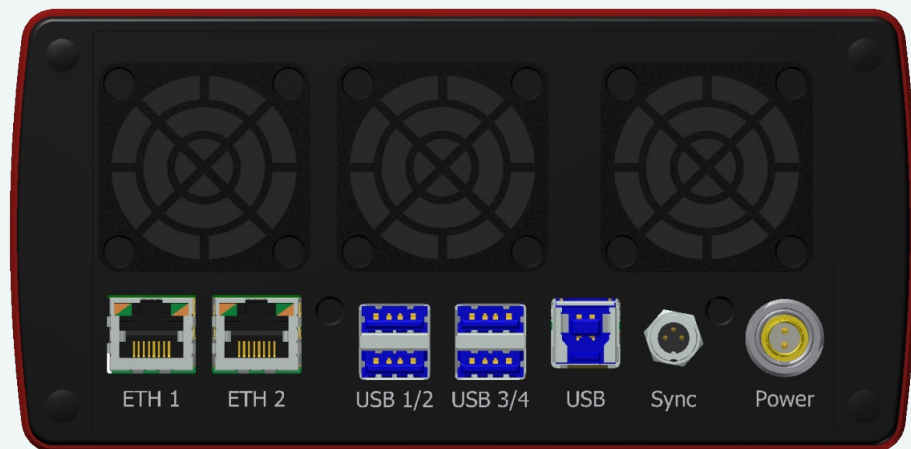

Technical data
VN8912A

Processor	Intel Core-i7, 2x 1.7 GHz, 4 MB Cache
Memory	4 GB
Hard drive	CFast card, 8 GB (two partitions, 4 GB each)
Transceiver	Depends on the plug-in module and its Piggybacks
PC interface	USB 3.0, SuperSpeed
Temperature range	Operating: 0 °C... +50 °C Shipping and storage: -40 °C... +85 °C
Relative humidity of ambient air	15 %...95 %, non-condensing
USB 1/2/3/4 output current	Max. 1350 mA, all four ports combined
External power supply	10 V...36 V DC
Power consumption	Typ. 16 W @ 24 V without plug-in module
Start-up time	Approx. 25 seconds
Dimensions (LxWxH)	183 mm x 172 mm x 85 mm (without plug-in module) 190 mm x 172 mm x 85 mm (with plug-in module)
Operating system requirements on Host PC	Windows 10 (x64, 64 bit) Windows 11 (x64, 64 bit)
Ethernet	1000BASE-T/100BASE-TX/10BASE-T
Supported plug-in modules	VN8912: VN8950/VN8970/VN8972 VN8912A: VN8970/VN8972



Note

EUROPE - Information according REACH:
The battery required for the real-time clock contains 1,2-Dimethoxyethane.

2.3 Plug-in Modules

2.3.1 VN8970 FlexRay/CAN/LIN Module

Description

The VN8970 FlexRay/CAN/LIN Module is a plug-in module for VN8911, VN8912A as well as VN8914 and has a FlexRay channel as well as several CAN/LIN channels. In addition, a ninth channel is available for dedicated digital-analog input/output tasks.

VN8970 with five plug-in locations for transceivers

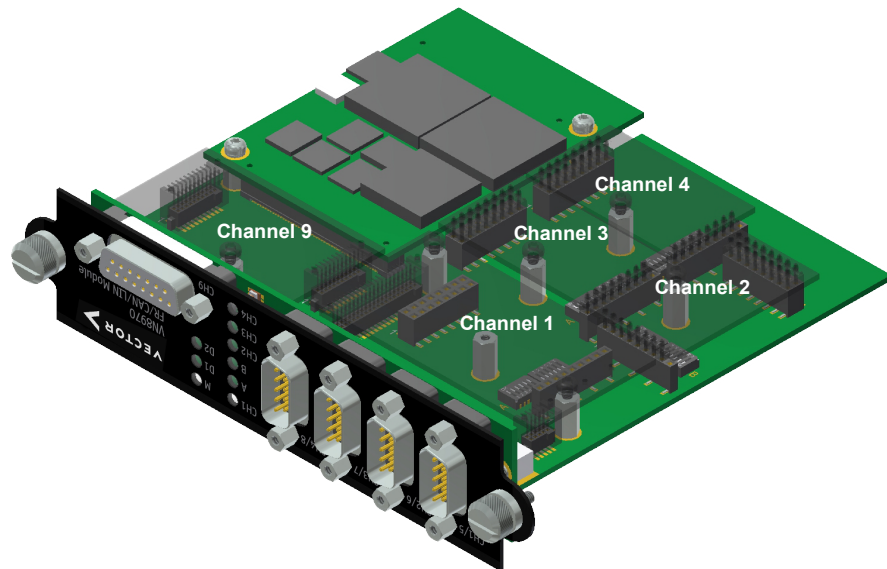

Figure 21: VN8970 FR/CAN/LIN Module with Piggyback plug-in locations

Bus configuration

The plug-in module's greatest asset is its five plug-in locations for add-ons (primary channels). Depending on requirements, **electrically isolated** CAN High-Speed, CAN Low-Speed, CAN Single Wire, J1708, LIN or FlexRay transceivers (Piggybacks) may be used. In addition, four capacitively decoupled built-in CAN TJA1051 (high-speed) transceivers are available (secondary channels).

In the plug-in location for channel 1, an FRpiggy can be inserted for a two-channel FlexRay connection (A and B of a cluster). Alternatively, a CANpiggy or LINpiggy can be used. Channels 2 to 4 are reserved for CANpiggies and LINpiggies.

CANpiggies must be populated in ascending order; LINpiggies in descending order (see examples). J1708 should be handled like CAN.

Channel 9 is reserved for dedicated IO Piggybacks.



Note

Inserting order

FRpiggy: CH1.

LINpiggies: CH4...CH1.

CAN/J1708piggies: CH1...CH4, but after an FRpiggy and before LINpiggies.

Piggyback order

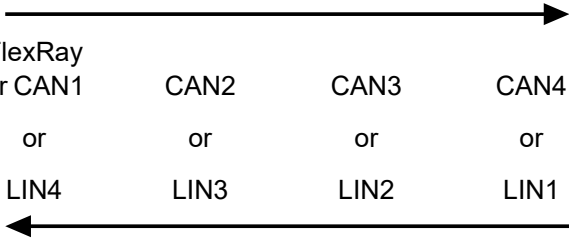
Primary	CH1	CH2	CH3	CH4	CH9
Piggyback					IO
	FlexRay or CAN1 or LIN4	CAN2 or LIN3	CAN3 or LIN2	CAN4 or LIN1	
Secondary	CH5	CH6	CH7	CH8	-
Built-in Transceiver	CAN 1051cap	CAN 1051cap	CAN 1051cap	CAN 1051cap	-



Note

CH5, CH6, CH7, and CH8 are equipped with built-in CAN TJA1051 transceivers. **CH5 will be deactivated** if an FRpiggy is inserted in the plug-in location for channel 1 and the pin assignment accordingly set via the DIP switches.

Each empty plug-in location (except for CH9) is loaded with a built-in transceiver from the secondary channel according to the DIP switch settings.







Reference

Further information on DIP switches can be found on page 36.

Examples

The following tables show examples of possible configurations (a list of all possible channel configurations can be found in section **Technical data** on page 42):

4x CAN
without Piggybacks

	 CH1/CH5	 CH2/CH6	 CH3/CH7	 CH4/CH8	 CH9
Piggyback	-	-	-	-	-
Primary	CH1	CH2	CH3	CH4	CH9
	↑	↑	↑	↑	
Built-in Transceiver	CAN 1051cap	CAN 1051cap	CAN 1051cap	CAN 1051cap	
Secondary	CH5	CH6	CH7	CH8	

Configuration

CH1: no Piggyback, built-in CAN 1051cap transceiver (CH5).
CH5: not usable.





CH2: no Piggyback, built-in CAN 1051cap transceiver (CH6).
CH6: not usable.

CH3: no Piggyback, built-in CAN 1051cap transceiver (CH7).
CH7: not usable.

CH4: no Piggyback, built-in CAN 1051cap transceiver (CH8).
CH8: not usable.

CH9: no Piggyback.

8x CAN
1x IO

	 CH1/CH5	 CH2/CH6	 CH3/CH7	 CH4/CH8	 CH9
Piggyback	CAN	CAN	CAN	CAN	IO
Primary	CH1	CH2	CH3	CH4	CH9
	-				
Built-in Transceiver	CAN 1051cap	CAN 1051cap	CAN 1051cap	CAN 1051cap	
Secondary	CH5	CH6	CH7	CH8	

Configuration

CH1: CANpiggy.
CH5: built-in CAN 1051cap transceiver.





CH2: CANpiggy.
CH6: built-in CAN 1051cap transceiver.

CH3: CANpiggy.
CH7: built-in CAN 1051cap transceiver.

CH4: CANpiggy.
CH8: built-in CAN 1051cap transceiver.

CH9: IOpiggy.

1x FlexRay A/B
6x CAN

					
	CH1/CH5	CH2/CH6	CH3/CH7	CH4/CH8	CH9
Piggyback	FlexRay	CAN	CAN	CAN	-
Primary	CH1	CH2	CH3	CH4	CH9
Built-in Transceiver	/	CAN 1051cap	CAN 1051cap	CAN 1051cap	-
Secondary	CH5	CH6	CH7	CH8	-

Configuration

CH1: FRpiggy.
CH5: not usable due to FRpiggy.





CH2: CANpiggy.
CH6: built-in CAN 1051cap transceiver.

CH3: CANpiggy.
CH7: built-in CAN 1051cap transceiver.

CH4: CANpiggy.
CH8: built-in CAN 1051cap transceiver.

CH9: no Piggyback.

1x FlexRay A/B
3x CAN
1x LIN
1x IO

					
	CH1/CH5	CH2/CH6	CH3/CH7	CH4/CH8	CH9
Piggyback	FlexRay	-	-	LIN	IO
Primary	CH1	CH2	CH3	CH4	CH9
Built-in Transceiver	/	CAN 1051cap	CAN 1051cap	CAN 1051cap	-
Secondary	CH5	CH6	CH7	CH8	-

Configuration

CH1: FRpiggy.
CH5: not usable due to FRpiggy.





CH2: no Piggyback, built-in CAN 1051cap transceiver (CH6).
CH6: not usable.

CH3: no Piggyback, built-in CAN 1051cap transceiver (CH7).
CH7: not usable.

CH4: LINpiggy.
CH8: built-in CAN 1051cap transceiver.

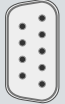
CH9: IOpiggy.

1x FlexRay A/B
4x CAN
1x LIN

	 CH1/CH5	 CH2/CH6	 CH3/CH7	 CH4/CH8	 CH9
Piggyback	FlexRay	CAN	-	LIN	-
Primary	CH1	CH2	CH3	CH4	CH9
	-	-	↑	-	
Built-in Transceiver	/	CAN 1051cap	CAN 1051cap	CAN 1051cap	
Secondary	CH5	CH6	CH7	CH8	

Configuration

- CH1: FRpiggy.
- CH5: not usable due to FRpiggy.

- CH2: CANpiggy.
- CH6: built-in CAN 1051cap transceiver.

- CH3: no Piggyback, built-in CAN 1051cap transceiver (CH7).
- CH7: not usable.

- CH4: LINpiggy.
- CH8: built-in CAN 1051cap transceiver.

- CH9: no Piggyback.



Reference

A list of compatible Piggybacks can be found in the accessories manual or on our website.

Double assignment of D-SUB9 connectors Before installing a Piggyback in the plug-in location, the pin assignment of the D-SUB9 connector has to be selected via DIP switches, which can be found at the plug-in locations.

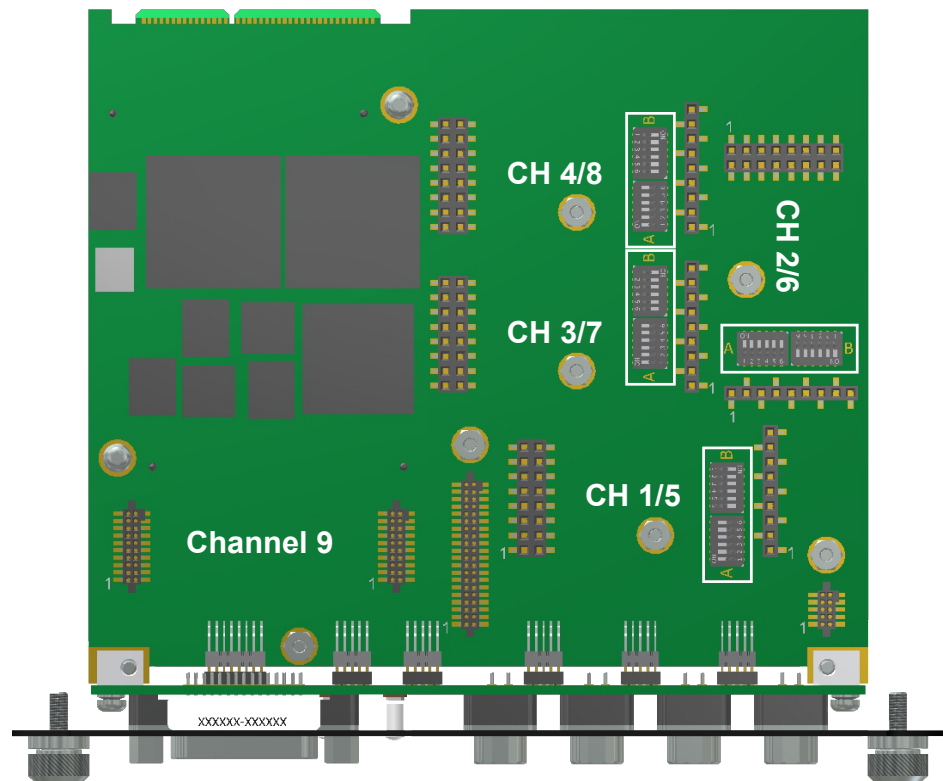

Figure 22: Channel 1...8 with DIP switches

Pin assignment CH1 ... CH8

The pin assignments of the D-SUB9 connectors depend on the used bus transceiver configuration inside the VN8970. A list of compatible Piggybacks can be found in the [accessories manual](#) or on our [website](#).

► **No Piggyback inserted**

If no Piggyback is inserted, only the built-in CAN transceiver is active (no double assignment at the D-SUB9 connector):

Pin	Assignment
1	Not connected
2	1051cap CAN Low
3	GND
4	Not connected
5	Shield
6	Not connected
7	1051cap CAN High
8	Not connected
9	Not connected

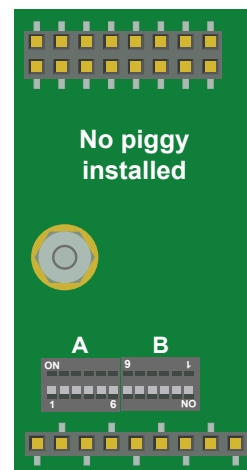

Setting of DIP switches
A: all, off / B: all, on'

► **CAN/LIN Piggyback inserted**

If a CAN- or LINpiggy is inserted, the pin assignment at the D SUB9 connector is as follows:

Pin	Assignment
1	1051cap CAN Low
2	Piggyback-dependent
3	Piggyback-dependent
4	Piggyback-dependent
5	Shield
6	GND
7	Piggyback-dependent
8	1051cap CAN High
9	Piggyback-dependent



Setting of DIP switches
A: all ,on' / B: all ,off'



Example

CANpiggy 1041Amag

The following example shows the pin assignment of CH1 and CH5 if a CANpiggy 1041Amag is inserted in the plug-in location 1.

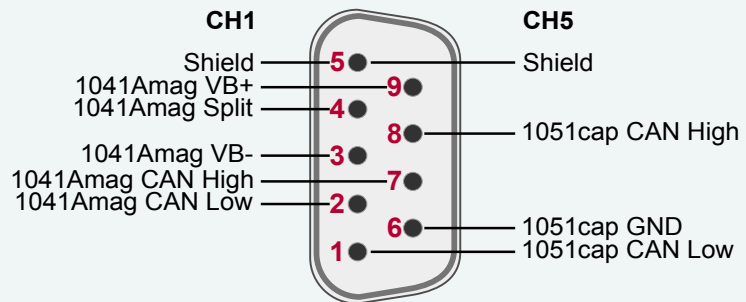

CAN/LIN Y cable

Use the CANcable 2Y to access both channels on separate D-SUB9 connectors (see accessories manual, part number 05075).

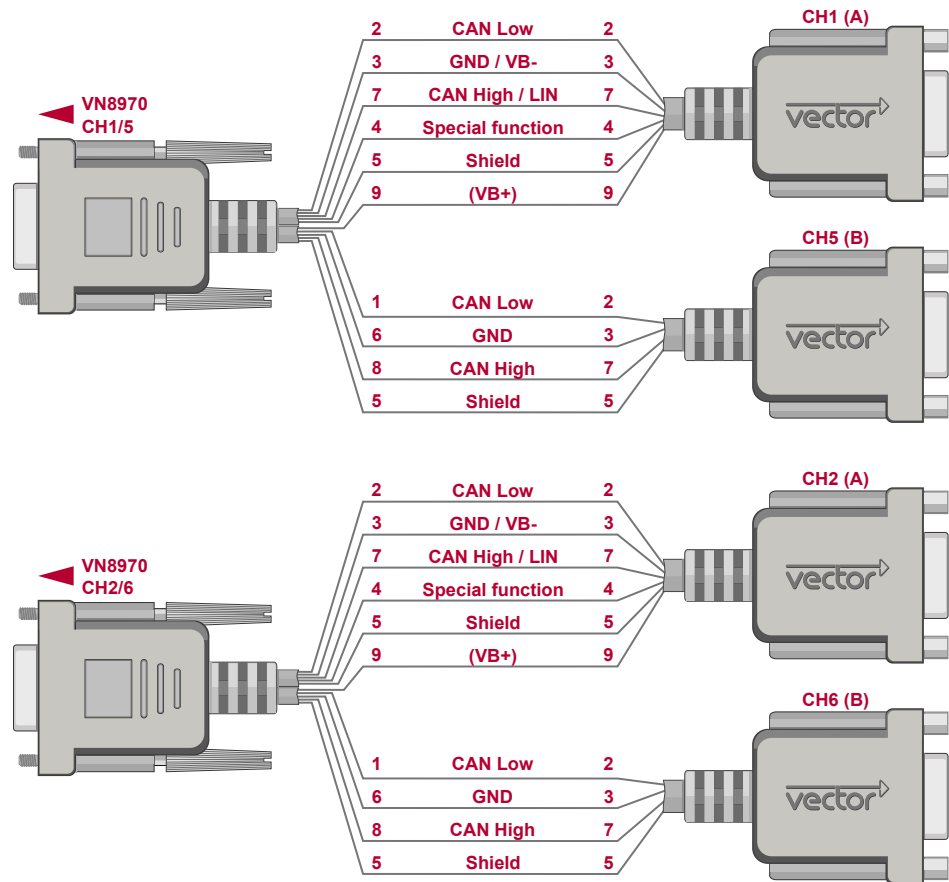
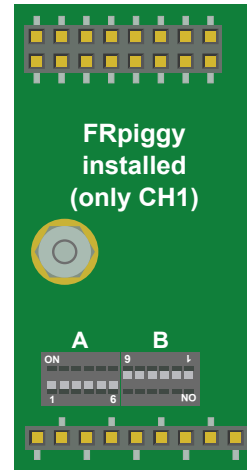

Figure 23: Example with 2x CANcable 2Y connected to VN8970

► **FlexRay Piggyback inserted**

If an FRpiggy is inserted, the pin assignment at the D SUB9 connector is as follows:

Pin	Assignment
1	Piggyback-dependent
2	FlexRay BM A
3	FlexRay GND
4	FlexRay BM B
5	Shield
6	Piggyback-dependent
7	FlexRay BP A
8	FlexRay BP B
9	Piggyback-dependent



Setting of DIP switches
A: all ,off' / B: all ,off'



Example

FRpiggy 1082cap

The following example shows the pin assignment of the FlexRay channels A and B at CH1 if an FRpiggy 1082cap is inserted in the plug-in location 1 (CH5 is disabled).

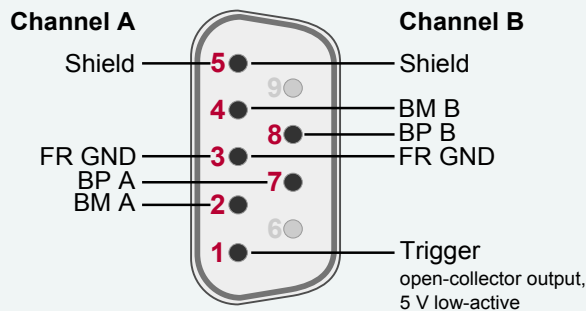

FlexRay Y cable

Use the FRcableAB to access channel A and B on separate D-SUB9 connectors (see accessories manual).

Connections

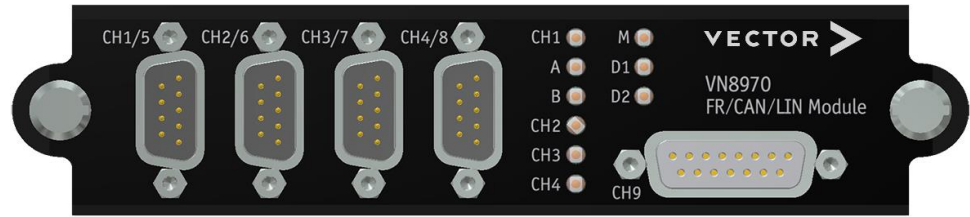

Figure 24: VN8970 with 4x D-SUB9 and 1x D-SUB15

- ▶ **CH1**
D-SUB9 connector for FlexRay, CAN or LIN (depending on Piggyback).
- ▶ **CH2 ... CH4**
D-SUB9 connector for CAN or LIN (depending on Piggyback).
- ▶ **CH5**
Fix CAN TJA1051cap (not available if FlexRay is being used at CH1).
- ▶ **CH6 ... CH8**
Fix CAN TJA1051cap.
- ▶ **CH9**
D-SUB15 socket for versatile tasks with the IOpiggy 8642. A detailed description can be found in the [accessories manual](#).

LEDs

- ▶ **CH1 ... CH4 (with CAN-/LINpiggy)**
Multicolored channel LEDs, each indicating the bus activity for CAN or LIN.

Color	Description
Green	Data frames have been sent or received correctly. The flashing frequency varies according to the message rate.
Orange	Error frames have been sent or received. The flashing frequency varies according to the message rate.
Red	Bus off.

- ▶ **CH1 (with FRpiggy)**
Multicolored channel LED which indicates the sync state of FlexRay.

Color	Description
Off	FlexRay Communication Controller offline.
Green	FlexRay Communication Controller synchronized.
Orange	FlexRay Communication Controller not synchronized.
Red	Error.

- ▶ **A/B**
Lights up, when data is received or transmitted on channel A/B.

▶ M

Multicolored LED that indicates the status of the plug-in module.

Color	Description
Green	The plug-in module is ready for operation/running measurement.
Orange	The plug-in module is booting. Please wait.
Red	Error, plug-in module is not ready for operation. Turn off the power supply and make sure that the plug-in module is inserted properly. Try to restart the module.

▶ D1

Multicolored LED that indicates the status of the Base Module.

Color	Description
Green	On: Measurement is running. Flashing: The Base Module is ready for measurement.
Orange	On: The Base Module can be accessed (e. g. for updates), but no measurement is possible. Flashing: The Base Module is booting. Please wait.
Red	Common error.
-	Off, fatal error.

▶ D2

Multicolored LED that indicates the state of the CANape RTKernel.

Color	Description
Green	On: Measurement is running. Flashing: RTKernel ready for measurement.
Orange	On: Warning (hardware). Flashing: Warning RTKernel.
Red	On: Error (hardware). Flashing: Error RTKernel.
-	RTKernel inactive.

Technical data

Power supply	By Base Module
Micro controller	ATMEL AT91SAM9 32 Bit 400 MHz
Channel configurations	Configurable with Piggybacks 1x FlexRay, 6x CAN 1x FlexRay, 5x CAN, 1x LIN 1x FlexRay, 4x CAN, 2x LIN 8x CAN 7x CAN, 1x LIN 6x CAN, 2x LIN 5x CAN, 3x LIN 4x CAN, 4x LIN Additional digital/analog IO channel
FlexRay channels	1 (with sub channels A and B)
FlexRay controller (Analyses)	Bosch E-Ray (FPGA)
FlexRay controller (Startup)	Fujitsu MB88121
FlexRay transmitter buffer	2 MB
CAN/CAN FD controller	Vector CAN/CAN FD controller (FPGA); Full support of all CANoe.CAN functions, e. g. sending error frames, bus load measurement and ListenOnly mode.
LIN controller	Vector LIN controller (FPGA) compatible to LIN1.3, LIN2.0, LIN2.1, and J2602: Full support of all CANoe.LIN functions, e. g. conformity tests, stress functions, and flash mode of 7269 transceiver.
Supported transceivers	Please find the list of valid combinations in section "Transceiver Compatibility" in the separate accessories manual on our website.
On board transceiver	4x NXP TJA1051 with electrical isolation
Interface to Base Module	PCI Express x1
Temperature range	Operating: -40 °C...+65 °C Shipping and storage: -40 °C...+85 °C
Relative humidity of ambient air	15 %...95 %, non-condensing
Power consumption	Typ. 7 W
Time stamp accuracy	1 µs

2.3.2 VN8972 FlexRay/CAN/LIN Module

Description

The VN8972 FlexRay/CAN/LIN Module is a plug-in module for VN8912A as well as VN8914 and has two FlexRay channels (each with sub channel A and B) as well as several CAN/LIN channels. In addition, a ninth channel is available for dedicated digital-analog in-put/output tasks.

VN8972 with five plug-in locations for transceivers

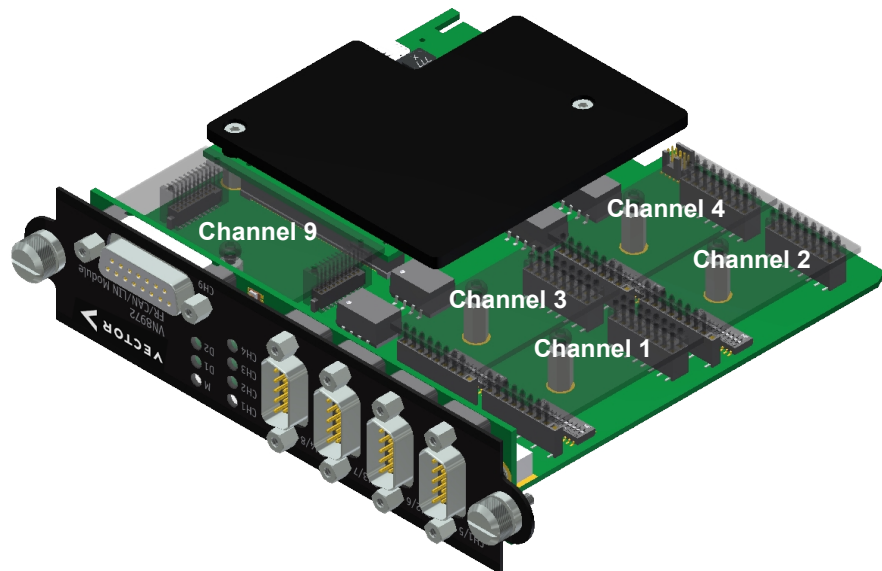

Figure 25: VN8972 FR/CAN/LIN Module with Piggyback plug-in locations

Bus configuration

The Plug-in module's greatest asset is its five plug-in locations for add-ons (primary channels). Depending on requirements, **electrically isolated** CAN High-Speed, CAN Low-Speed, CAN Single Wire, J1708, LIN or FlexRay transceivers (Piggybacks) may be used. In addition, four capacitively decoupled built-in CAN TJA1051 (high-speed) transceivers are available (secondary channels).

In the plug-in location for channel 1 and channel 2, an FRpiggyC can be inserted for a two-channel FlexRay connection (A and B of a cluster). Alternatively, a CANpiggy or LINpiggy can be used. Channels 3 and 4 are reserved for CANpiggies and LINpiggies. **CANpiggies must be populated in ascending order; LINpiggies in descending order** (see examples). J1708 should be handled like CAN.

Channel 9 is reserved for dedicated IO Piggybacks.



Note

Inserting order

FRpiggies: CH1...CH2.

LINpiggies: CH4...CH1.

CAN/J1708piggies: CH1...CH4, but after FRpiggies and before LINpiggies.



Caution!

The VN8972 plug-in module is equipped with a heat spreader which may become hot during operation. To avoid injury, do not touch the heat spreader when you remove the plug-in module right after operation.

Piggyback order

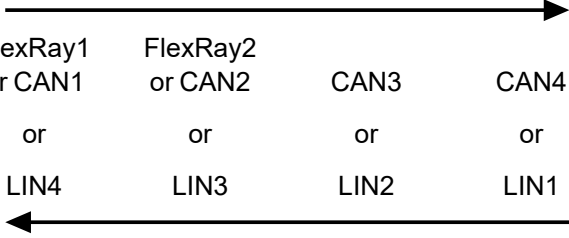
Primary	CH1	CH2	CH3	CH4	CH9
Piggyback					IO
	FlexRay1 or CAN1 or LIN4	FlexRay2 or CAN2 or LIN3	CAN3 or LIN2	CAN4 or LIN1	
Secondary	CH5	CH6	CH7	CH8	-
Built-in Transceiver	CAN 1051cap	CAN 1051cap	CAN 1051cap	CAN 1051cap	-



Note

CH5, CH6, CH7, and CH8 are equipped with built-in CAN TJA1051 transceivers. **CH5 (CH6) will be deactivated** if an FRpiggyC is inserted in the plug-in location for CH1 (CH2) and the pin assignment accordingly set via the DIP switches.

Each empty plug-in location (except for CH9) is loaded with a built-in transceiver from the secondary channel according to the DIP switch settings.







Reference

Further information on DIP switches can be found on page 48.

Examples

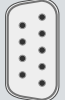
The following tables show examples of possible configurations (a list of all possible channel configurations can be found in section **Technical data** on page 54):

4x CAN
without Piggybacks

	 CH1/CH5	 CH2/CH6	 CH3/CH7	 CH4/CH8	 CH9
Piggyback	-	-	-	-	-
Primary	CH1	CH2	CH3	CH4	CH9
	↑	↑	↑	↑	
Built-in Transceiver	CAN 1051cap	CAN 1051cap	CAN 1051cap	CAN 1051cap	
Secondary	CH5	CH6	CH7	CH8	

Configuration

CH1: no Piggyback, built-in CAN 1051cap transceiver (CH5).
CH5: not usable.





CH2: no Piggyback, built-in CAN 1051cap transceiver (CH6).
CH6: not usable.

CH3: no Piggyback, built-in CAN 1051cap transceiver (CH7).
CH7: not usable.

CH4: no Piggyback, built-in CAN 1051cap transceiver (CH8).
CH8: not usable.

CH9: no Piggyback.

8x CAN
1x IO

	 CH1/CH5	 CH2/CH6	 CH3/CH7	 CH4/CH8	 CH9
Piggyback	CAN	CAN	CAN	CAN	IO
Primary	CH1	CH2	CH3	CH4	CH9
	-				
Built-in Transceiver	CAN 1051cap	CAN 1051cap	CAN 1051cap	CAN 1051cap	
Secondary	CH5	CH6	CH7	CH8	

Configuration

CH1: CANpiggy.
CH5: built-in CAN 1051cap transceiver.





CH2: CANpiggy.
CH6: built-in CAN 1051cap transceiver.

CH3: CANpiggy.
CH7: built-in CAN 1051cap transceiver.

CH4: CANpiggy.
CH8: built-in CAN 1051cap transceiver.

CH9: IOpiggy.

2x FlexRay A/B
4x CAN

					
	CH1/CH5	CH2/CH6	CH3/CH7	CH4/CH8	CH9
Piggyback	FlexRay	FlexRay	CAN	CAN	-
Primary	CH1	CH2	CH3	CH4	CH9
	-				
Built-in Transceiver	/	/	CAN 1051cap	CAN 1051cap	
Secondary	CH5	CH6	CH7	CH8	

Configuration

CH1: FRpiggyC.
CH5: not usable due to FRpiggyC.





CH2: FRpiggyC.
CH6: not usable due to FRpiggyC.

CH3: CANpiggy.
CH7: built-in CAN 1051cap transceiver.

CH4: CANpiggy.
CH8: built-in CAN 1051cap transceiver.

CH9: no Piggyback.

2x FlexRay A/B
2x CAN
1x LIN
1x IO

					
	CH1/CH5	CH2/CH6	CH3/CH7	CH4/CH8	CH9
Piggyback	FlexRay	FlexRay	-	LIN	IO
Primary	CH1	CH2	CH3	CH4	CH9
	-	-	↑	-	
Built-in Transceiver	/	/	CAN 1051cap	CAN 1051cap	
Secondary	CH5	CH6	CH7	CH8	

Configuration

CH1: FRpiggyC.
CH5: not usable due to FRpiggyC.





CH2: FRpiggyC.
CH6: not usable due to FRpiggyC.

CH3: no Piggyback, built-in CAN 1051cap transceiver (CH7).
CH7: not usable.

CH4: LINpiggy.
CH8: built-in CAN 1051cap transceiver.

CH9: IOpiggy.

1x FlexRay A/B
4x CAN
1x LIN

	 CH1/CH5	 CH2/CH6	 CH3/CH7	 CH4/CH8	 CH9
Piggyback	FlexRay	CAN	-	LIN	-
Primary	CH1	CH2	CH3	CH4	CH9
	-	-	↑	-	
Built-in Transceiver	/	CAN 1051cap	CAN 1051cap	CAN 1051cap	
Secondary	CH5	CH6	CH7	CH8	

Configuration

CH1: FRpiggyC.

CH5: not usable due to FRpiggyC.

CH2: CANpiggy.

CH6: built-in CAN 1051cap transceiver.

CH3: no Piggyback, built-in CAN 1051cap transceiver (CH7).

CH7: not usable.

CH4: LINpiggy.

CH8: built-in CAN 1051cap transceiver.

CH9: no Piggyback.

A list of compatible Piggybacks can be found in the [accessories manual](#) or on our [website](#).

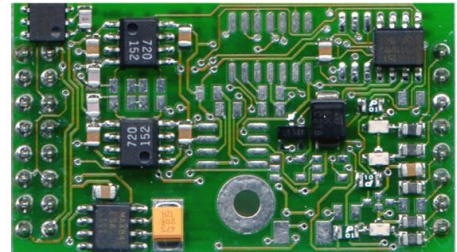

Figure 26: Piggyback

Double assignment of D-SUB9 connectors Before installing a Piggyback in the plug-in location, the pin assignment of the D-SUB9 connector has to be selected via DIP switches, which can be found at the plug-in locations.

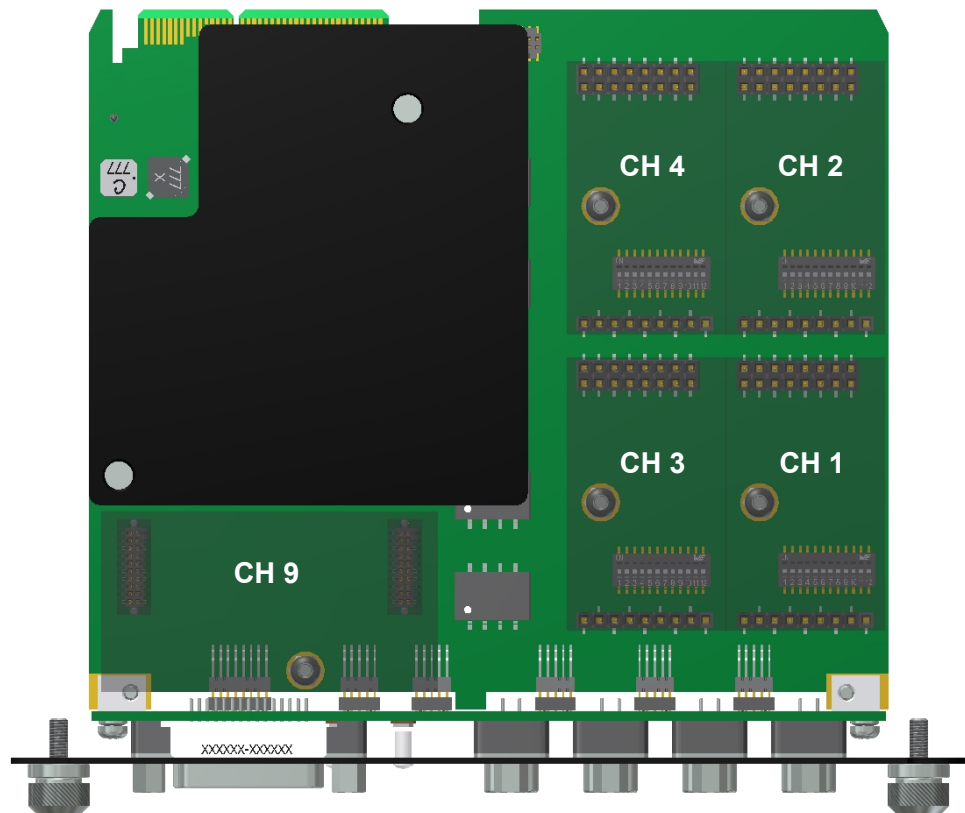

Figure 27: Channel 1..8 with DIP switches

Pin assignment CH1 ... CH8

The pin assignments of the D-SUB9 connectors depend on the used bus transceiver configuration inside the VN8972. A list of compatible Piggybacks can be found in the accessories manual or on our website.

▶ **No Piggyback inserted**

If no Piggyback is inserted, only the built-in CAN transceiver is active (no double assignment at the D-SUB9 connector):

Pin	Assignment
1	Not connected
2	1051cap CAN Low
3	GND
4	Not connected
5	Shield
6	Not connected
7	1051cap CAN High
8	Not connected
9	Not connected

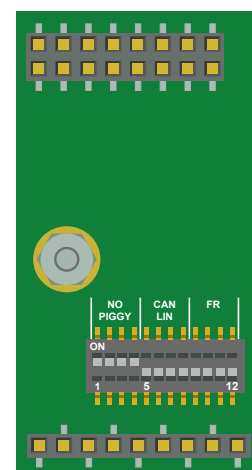

Setting of DIP switches 1...4: ON, 5...12: OFF

▶ **CAN/LIN Piggyback inserted**

If a CAN- or LINpiggy is inserted, the pin assignment at the D SUB9 connector is as follows:

Pin	Assignment
1	1051cap CAN Low
2	Piggyback-dependent
3	Piggyback-dependent
4	Piggyback-dependent
5	Shield
6	GND
7	Piggyback-dependent
8	1051cap CAN High
9	Piggyback-dependent

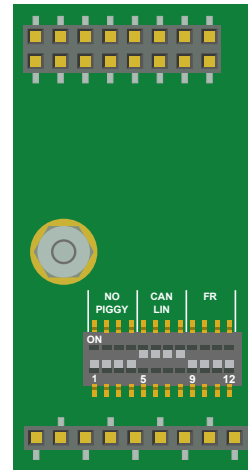

Setting of DIP switches
1...4: OFF, 5...8: ON, 9...12: OFF



Example

CANpiggy 1041Amag

The following example shows the pin assignment of CH1 and CH5 if a CANpiggy 1041Amag is inserted in the plug-in location 1.

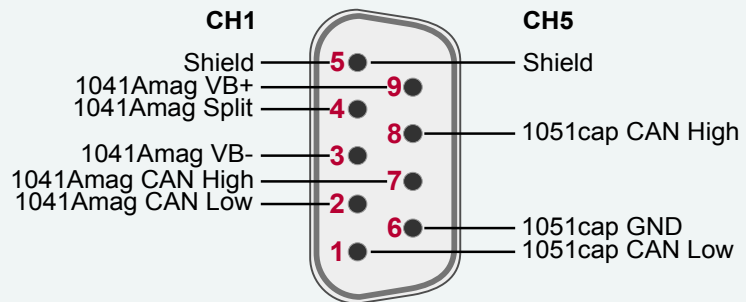

CAN/LIN Y cable

Use the CANcable 2Y to access both channels on separate D-SUB9 connectors (see accessories manual, part number 05075).

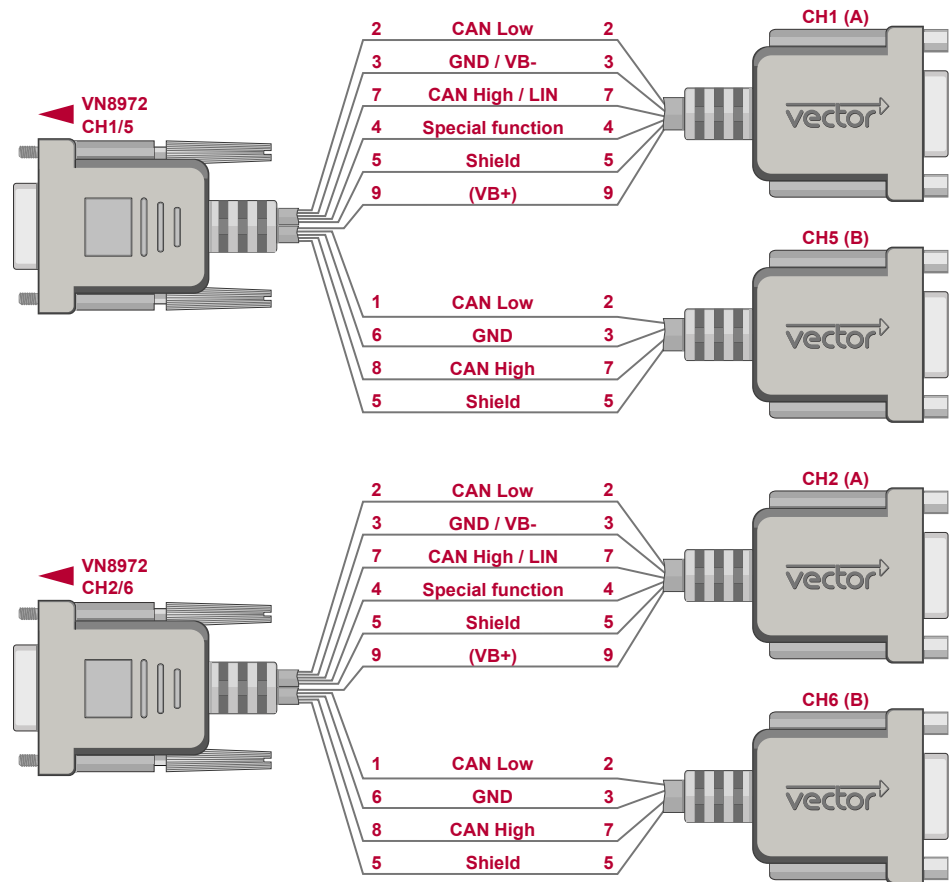
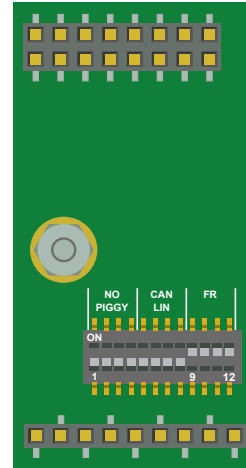

Figure 28: Example with 2x CANcable 2Y connected to VN8972

► **FlexRay Piggyback inserted**

If an FRpiggyC is inserted, the pin assignment at the D SUB9 connector is as follows:

Pin	Assignment
1	Piggyback-dependent
2	FlexRay BM A
3	FlexRay GND
4	FlexRay BM B
5	Shield
6	Piggyback-dependent
7	FlexRay BP A
8	FlexRay BP B
9	Piggyback-dependent



Setting of DIP switches
1...8: OFF, 9...12: ON



Example

FRpiggyC 1082cap

The following example shows the pin assignment of the FlexRay channels A and B at CH1 if an FRpiggyC 1082cap is inserted in the plug-in location 1 (CH5 is disabled).

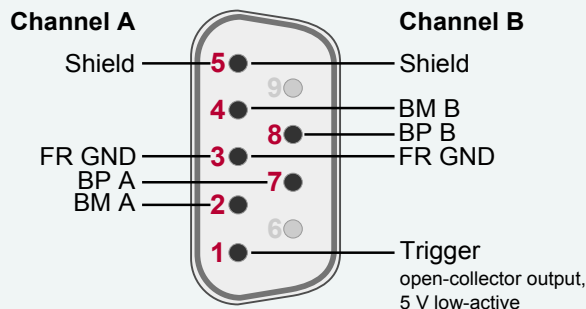

FlexRay Y cable

Use the FRcableAB to access channel A and B on separate D-SUB9 connectors (see accessories manual).

Connections

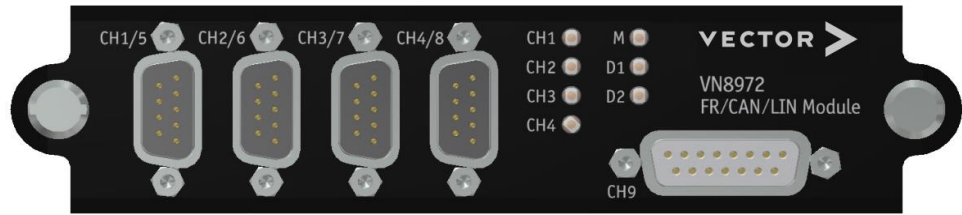

Figure 29: VN8972 with 4x D-SUB9 and 1x D-SUB15

- ▶ **CH1 ... CH2**
D-SUB9 connector for FlexRay, CAN or LIN (depending on Piggyback).
- ▶ **CH3 ... CH4**
D-SUB9 connector for CAN or LIN (depending on Piggyback).
- ▶ **CH5**
Fix CAN TJA1051cap (not available if FlexRay is being used at CH1).
- ▶ **CH6**
Fix CAN TJA1051cap (not available if FlexRay is being used at CH2).
- ▶ **CH7 ... CH8**
Fix CAN TJA1051cap.
- ▶ **CH9**
D-SUB15 socket for versatile tasks with the IOpiggy 8642. A detailed description can be found in the [accessories manual](#).

LEDs

- ▶ **CH1 ... CH4 (with CAN-/LINpiggies)**
Multicolored channel LEDs, each indicating the bus activity for CAN or LIN.

Color	Description
Green	Data frames have been sent or received correctly. The flashing frequency varies according to the message rate.
Orange	Error frames have been sent or received. The flashing frequency varies according to the message rate.
Red	Bus off.

- ▶ **CH1 ... CH2 (with FRpiggies)**
Multicolored channel LED which indicates the sync state of FlexRay.

Color	Description
Off	FlexRay Communication Controller offline.
Green	FlexRay Communication Controller synchronized.
Orange	On: FlexRay Communication Controller not synchronized. Flashing: FlexRay error frames and normal frames have been received.
Red	On: FlexRay Communication Controller in halt state. Flashing: FlexRay error frames on bus.

► **M**

Multicolored LED that indicates the status of the plug-in module.

Color	Description
Green	The plug-in module is ready for operation/running measurement.
Orange	The plug-in module is booting. Please wait.
Red	Error, plug-in module is not ready for operation. Turn off the power supply and make sure that the plug-in module is inserted properly. Try to restart the module.

► **D1**

Multicolored LED that indicates the status of the Base Module.

Color	Description
Green	On: Measurement is running. Flashing: The Base Module is ready for measurement.
Orange	On: The Base Module can be accessed (e. g. for updates), but no measurement is possible. Flashing: The Base Module is booting. Please wait.
Red	Common error.
-	Off, fatal error.

► **D2**

Multicolored LED that indicates the state of the CANape RTKernel.

Color	Description
Green	On: Measurement is running. Flashing: RTKernel ready for measurement.
Orange	On: Warning (hardware). Flashing: Warning RTKernel.
Red	On: Error (hardware). Flashing: Error RTKernel.
-	RTKernel inactive.

Technical data

Power supply	By Base Module
Micro controller	ATMEL AT91SAM9 32 Bit 400 MHz
Channel configurations	Configurable with Piggybacks 2x FlexRay, 4x CAN 2x FlexRay, 3x CAN, 1x LIN 2x FlexRay, 2x CAN, 2x LIN 1x FlexRay, 6x CAN 1x FlexRay, 5x CAN, 1x LIN 1x FlexRay, 4x CAN, 2x LIN 8x CAN 7x CAN, 1x LIN 6x CAN, 2x LIN 5x CAN, 3x LIN 4x CAN, 4x LIN Additional digital/analog IO channel
FlexRay channels	2 (each with sub channels A and B)
FlexRay controller (Analyses)	Bosch E-Ray (FPGA)
FlexRay controller (Startup)	Bosch E-Ray (FPGA)
FlexRay transmitter buffer	2 MB
CAN/CAN FD controller	Vector CAN/CAN FD controller (FPGA); Full support of all CANoe.CAN functions, e. g. sending error frames, bus load measurement and ListenOnly mode.
LIN controller	Vector LIN controller (FPGA) compatible to LIN1.3, LIN2.0, LIN2.1, and J2602: Full support of all CANoe.LIN functions, e. g. conformity tests, stress functions, and flash mode of 7269 transceiver.
Supported transceivers	Please find the list of valid combinations in section "Transceiver Compatibility" in the separate accessories manual on our website.
On board transceiver	4x NXP TJA1051 with electrical isolation
Interface to Base Module	PCI Express x1
Temperature range	Operating: 0 °C...+50 °C Shipping and storage: -40 °C...+85 °C
Relative humidity of ambient air	15 %...95 %, non-condensing
Power consumption	Typ. 8 W
Time stamp accuracy	1 µs

2.4 Accessories



Reference

Information on available accessories can be found in the separate accessories manual on our [website](#).

2.5 Mounting of Plug-in Modules and Piggybacks



Caution!

Always disconnect the power supply before assembling.



Caution!

Ensure an ESD safe working environment during disassembly and assembly. Avoid touching the top, bottom or connectors of the boards during this process to avoid ESD damage.



Caution!

The VN8972 plug-in module is equipped with a heat spreader which may become hot during operation. To avoid injury, do not touch the heat spreader when you remove the plug-in module right after operation.



Step by Step Procedure

1. Remove all cables from the Base Module.
2. Place the Base Module on the table so that the bus terminals point toward you.

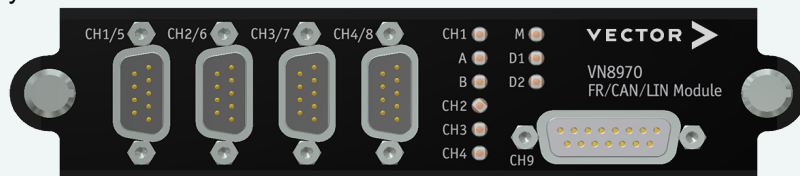

Figure 30: Plug-in module example

3. Unscrew the two mounting screws to loosen the plug-in module in the Base Module.
4. Carefully pull the plug-in module out of the Base Module.



Figure 31: Base Module example

5. Set DIP switches according to your needs (if available on the plug-in module)
6. Insert the desired Piggybacks at their appropriate mounting locations on the module. Please note that the single-line and dual-line connectors must not be bent sideways.

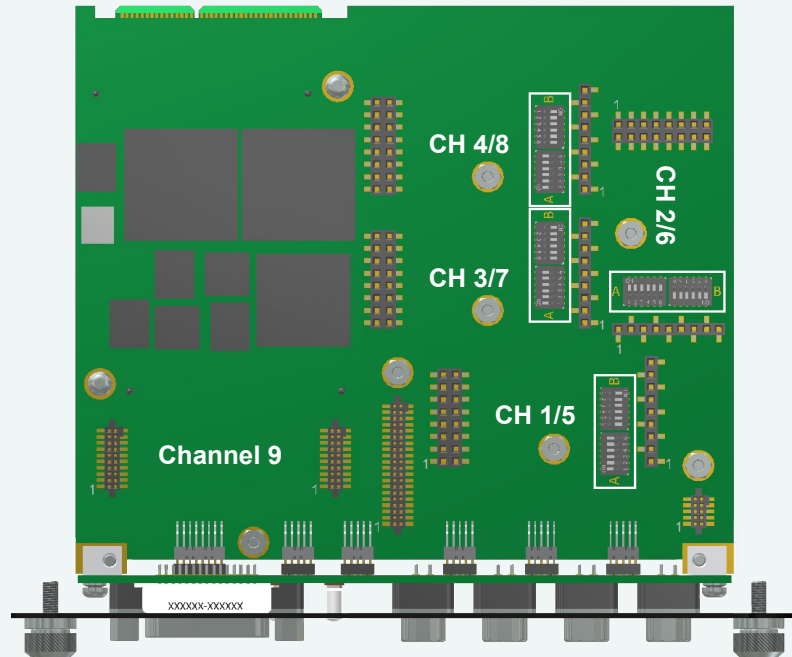

Figure 32: Piggyback locations on the VN8970 FlexRay/CAN/LIN module

7. Fasten each Piggyback with the proper screw and lock washer.
8. Now slowly insert the module into the Base Module on the guide rails. To prevent damage from electrostatic discharge, do not touch any of the components on the board.

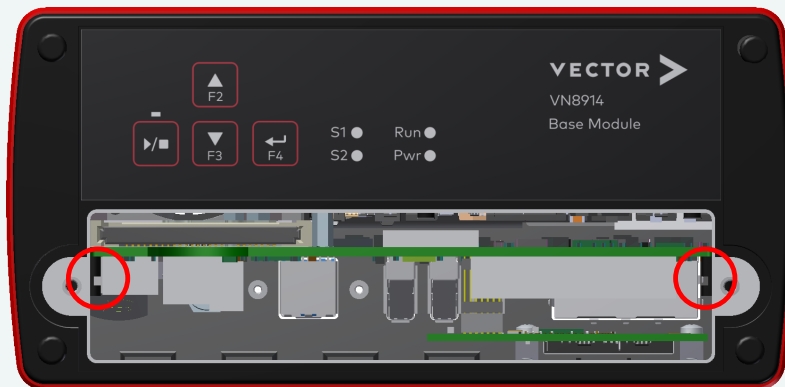

Figure 33: Base Module example

9. Tighten the mounting screws back in with sufficient force to secure the module in place.

**Note**

Please note that for successful operation a plug-in module with Piggybacks or built-in transceivers must be plugged into the Base Module and the DIP switches correctly set (if available).

**Note**

No other special installations are necessary for the plug-in modules on the PC. All that needs to be done is to install the Base Module on your PC.

3 Getting Started

In this chapter you find the following information:

3.1 Driver Installation	60
3.1.1 General Information	60
3.1.2 Installation Instructions	60
3.2 Vector Hardware Manager	63
3.2.1 Hardware Configuration	63
3.2.2 Tool Location and Help	63
3.3 Loop Tests	64
3.3.1 CAN	65
3.3.2 FlexRay	67

3.1 Driver Installation

3.1.1 General Information

The **Vector Driver Setup** allows the installation or the removal of Vector devices.

**Note**

Please note that you will need **Administrator Rights** for the following steps.

3.1.2 Installation Instructions

**Step by Step Procedure**

1. Execute the driver setup `\Drivers\Setup.exe` before the device is connected to the PC with the included USB cable.

If you have already connected the device to the PC, the **Windows found new Hardware** wizard appears. Close this wizard and then execute the driver setup.

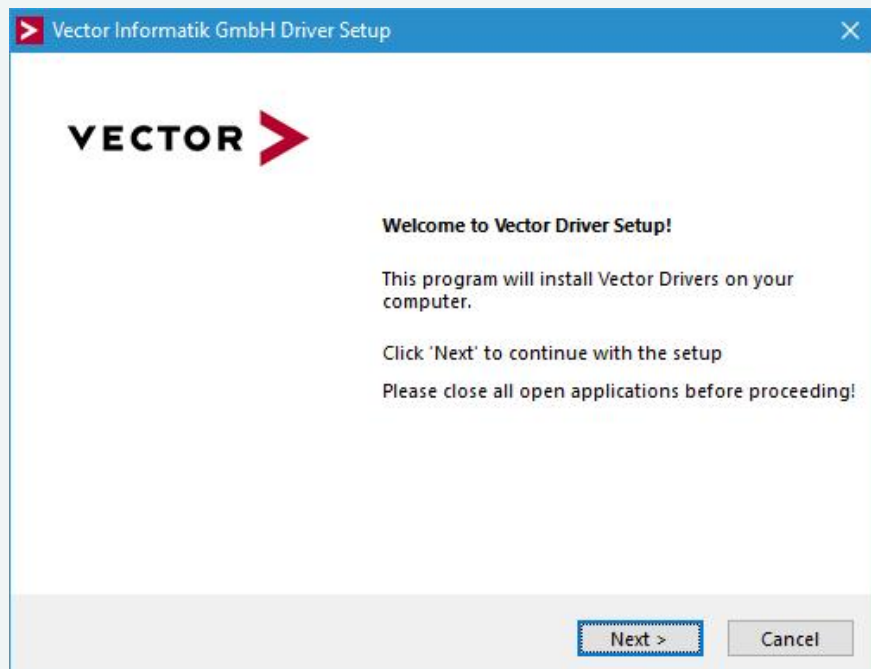

2. Click **[Next]** in the driver setup dialog. The initialization process starts.

- In the driver selection dialog, select your devices to be installed (or to be uninstalled).

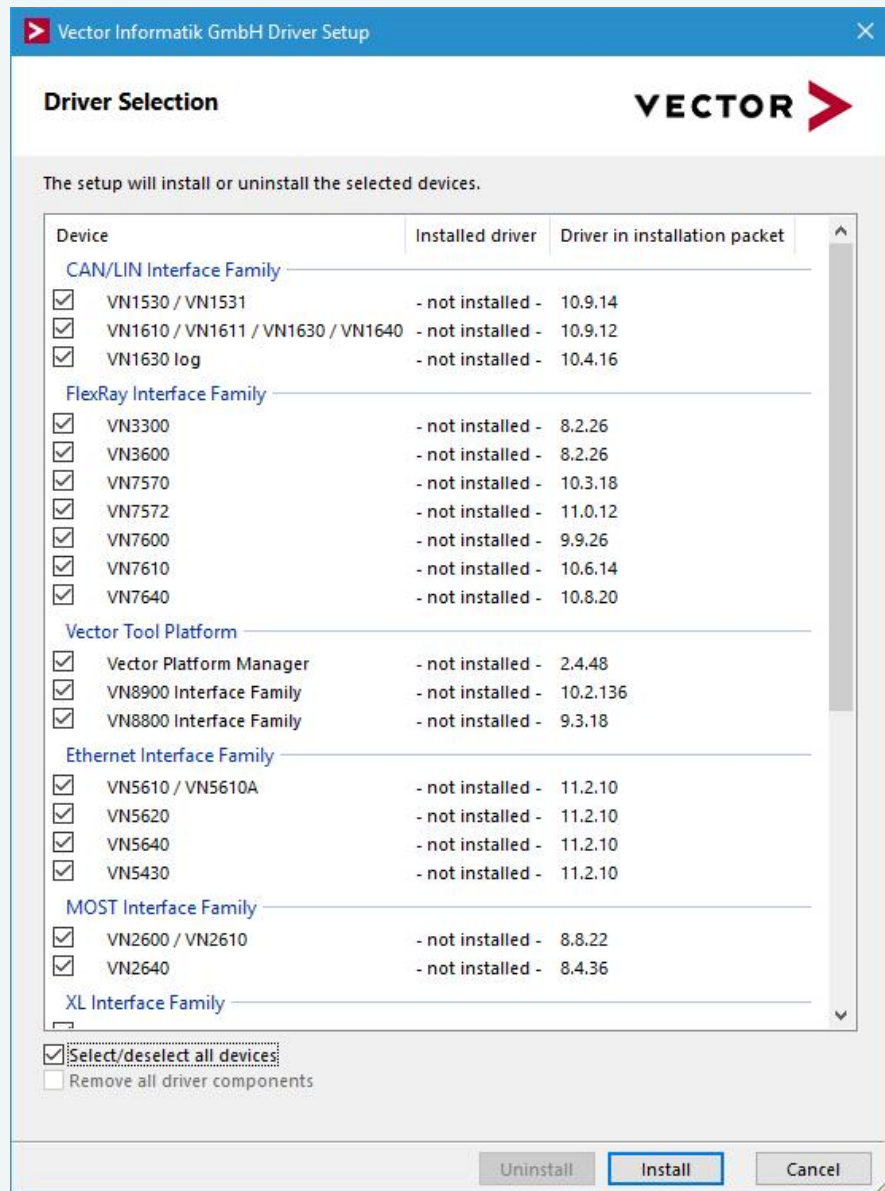

- Click **[Install]** to execute the driver installation, or **[Uninstall]** to remove existing drivers.
- A confirmation dialog appears. Click **[Close]** to exit. After successful installation, the device is ready for operation and can be connected to the PC with the included USB cable and powered by supplying external voltage (e. g. with an appropriate cable offered by Vector).

**Note**

During installation, you will be asked to update the drivers on your device. Select **[Yes]** to open the just installed **Vector Tool Platform Manager** (if selected before). In the tool, select your connected device and click on **[Update]**. If not connected, you can update your device anytime via:

```
C:\Program Files (x86)\Vector Platform Manager x.y\  
PlatformManager.exe.
```

Updating is always recommended.

3.2 Vector Hardware Manager

3.2.1 Hardware Configuration

General information

The **Vector Hardware Manager** is the successor of the Vector Hardware Config tool and a newly developed configuration and diagnostic tool for your installed Vector devices. It is strongly needed to set up your Vector devices for use with your Vector applications (e. g. CANoe, CANalyzer, CANape, XL API applications, ...).

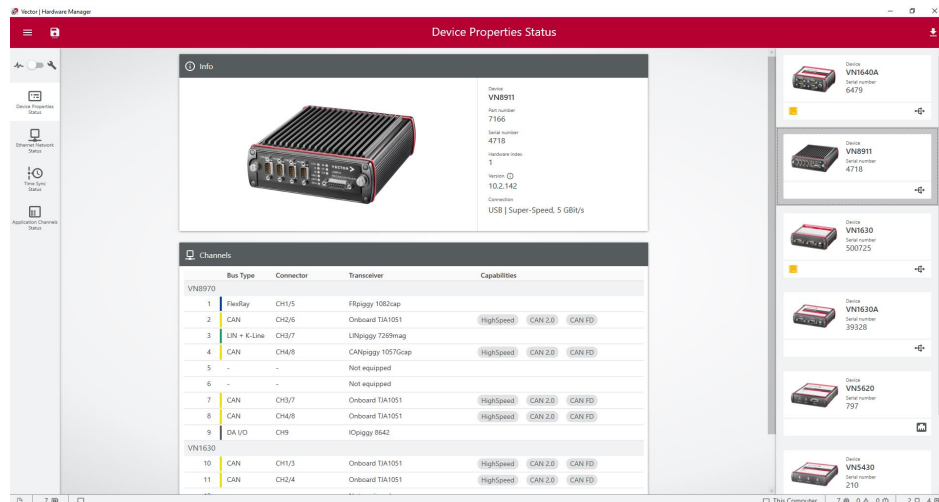

3.2.2 Tool Location and Help

After successful driver installation of your Vector device, you will find the Vector Hardware Manager in the Windows Start menu or in the installation folder:
`C:\Program Files (x86)\Vector Hardware Manager\vHardwareManager.exe`



Reference

Details, tips and instructions for the Vector Hardware Manager can be found in the supplied help. You can open the help by pressing **<F1>** in the Vector Hardware Manager or directly via:

`C:\Program Files (x86)\Vector Hardware Manager\Help01\HTML5\VectorHardwareManager.htm`

For a brief introduction, we recommend reading the sections **Basic Concept** and **Quick Start Guide**. Furthermore, we have provided additional information for you in the section **Tips and Tutorials**.

3.3 Loop Tests

Operation test

The test described here can be performed to check the functional integrity of the driver and the device. This test is identical for **Windows 10 / Windows 11** and independent of the used application.

3.3.1 CAN

Device test

The operating test for CAN requires either two high-speed or two low-speed transceivers and can be executed as follows:



Step by Step Procedure

1. Connect two CAN channels with a suitable cable.
If two high-speed transceivers are being used, we recommend our **CANcable1** (**CANcable0** for low-speed transceivers).
2. Start `\Drivers\Common\Loop3.exe` from the **Vector Driver Setup**.
This program accesses the Vector devices and transmits CAN messages.

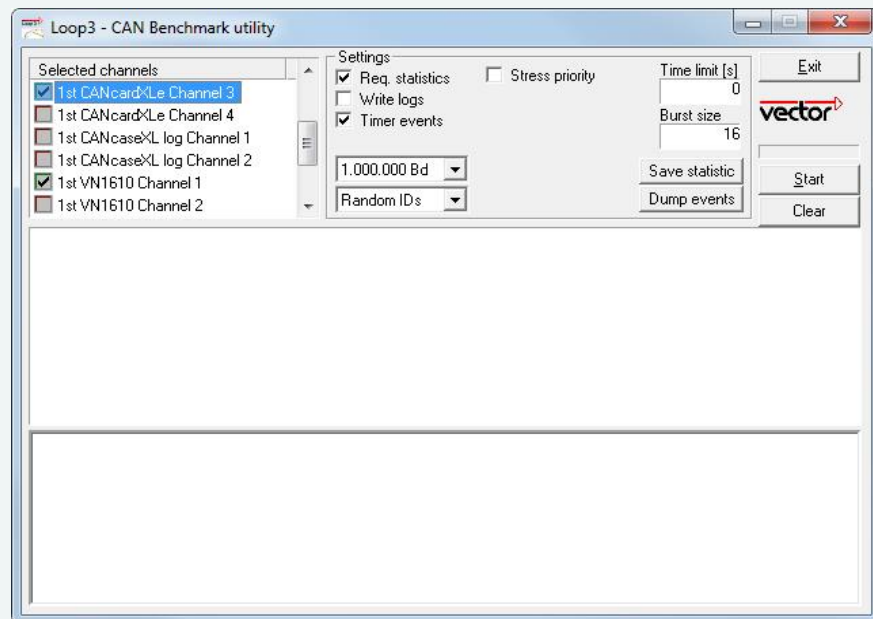

3. Select the connected CAN channels of the device(s) to be tested.

4. Set the appropriate baudrate depending on the transceiver being used (high-speed max. 1,000,000 Bd, low-speed max. 125,000 Bd).
5. Click **[Start]**.
6. You will see statistical data in the lower part of the window if the system has been configured properly.

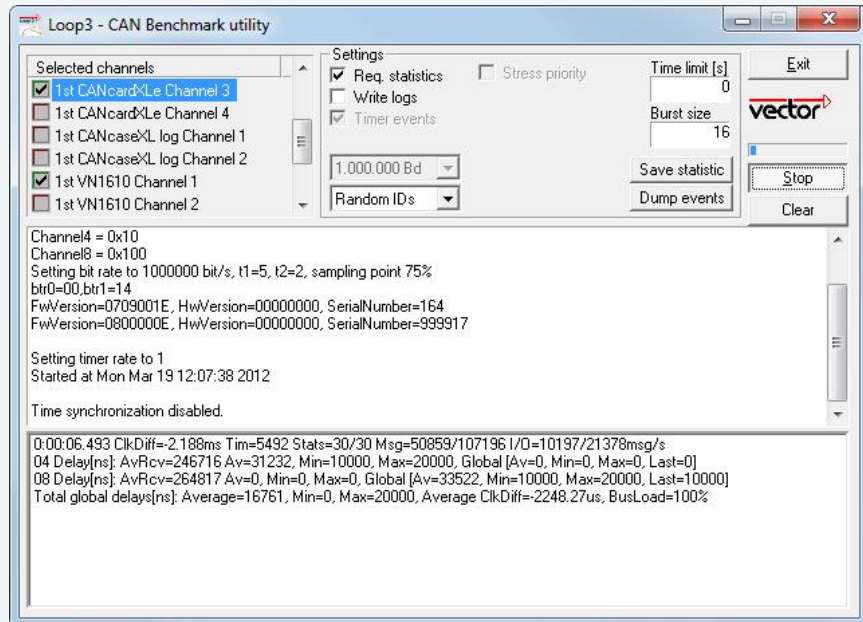

7. The test procedure can be terminated with the **[Stop]** button. An **OK** should appear in the upper part of the window.

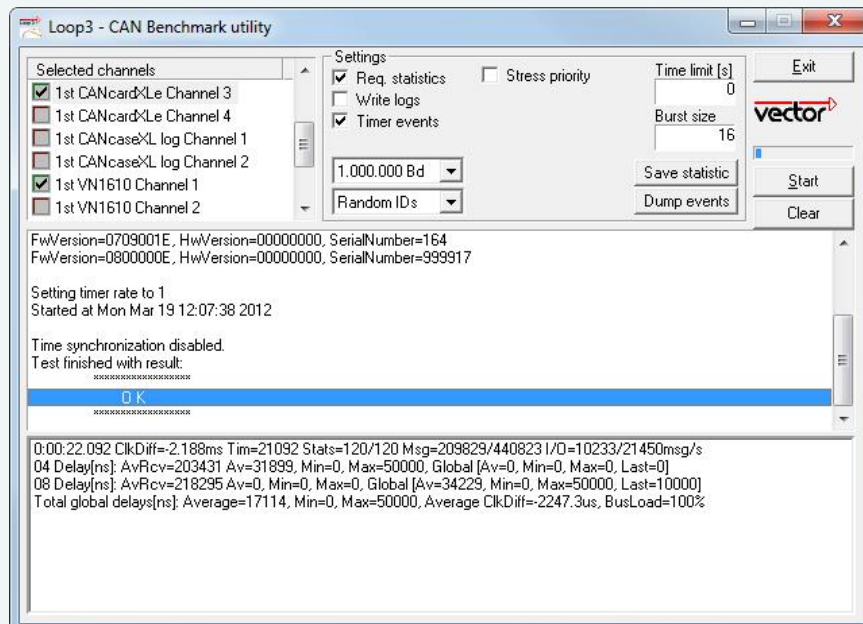

3.3.2 FlexRay

Device test

The operating test for FlexRay requires an inserted FRpiggy (except for VN7610) and can be executed as follows:



Step by Step Procedure

1. Remove the FlexRay cable if it is connected.
2. Start `\Drivers\Common\FRLoop.exe` from the **Vector Driver Setup**.
3. Execute the test.
4. If no error messages occur, the operating test was successful.

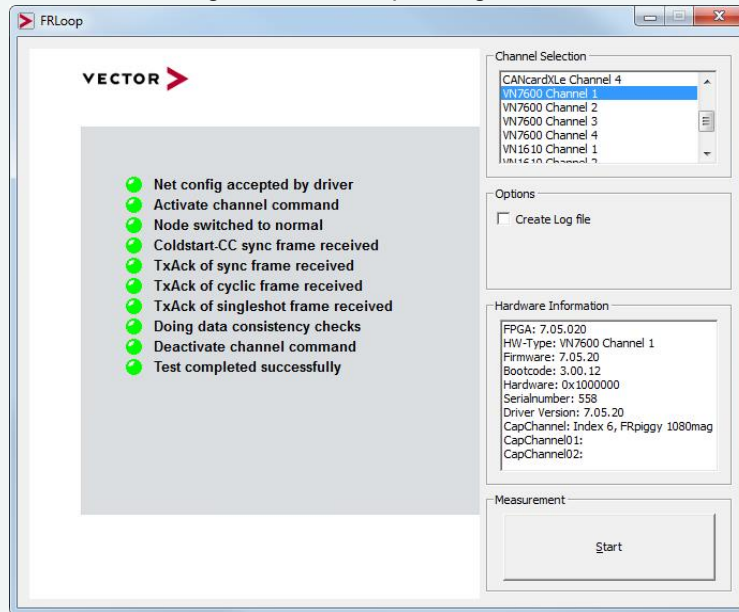

4 Time Synchronization

In this chapter you find the following information:

4.1 General Information	69
4.2 Software Sync	71
4.2.1 General Information	71
4.3 Hardware Sync	72
4.3.1 General Information	72
4.3.2 Configuration	73

4.1 General Information

Time stamps and events

Time stamps are useful when analyzing incoming or outgoing data or event sequences on a specific bus.

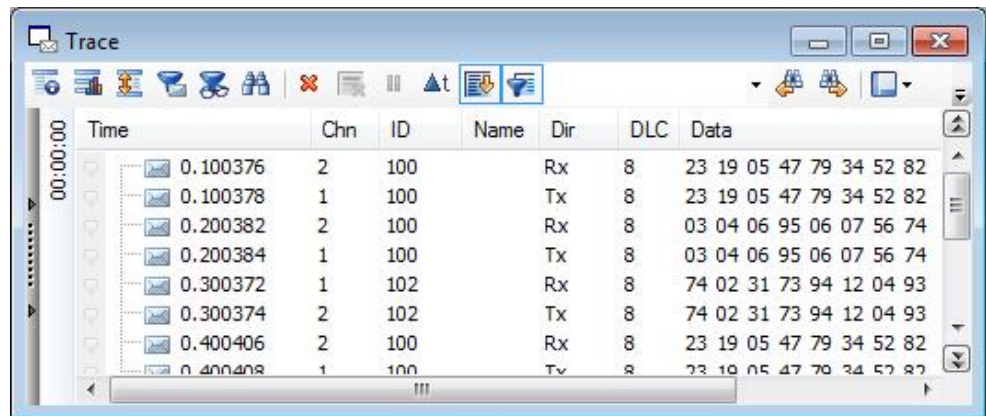

Figure 34: Time stamps of two CAN channels in CANalyzer

Generating time stamps

Each event which is sent or received by a Vector network interface has an accurate time stamp. Time stamps are generated for each channel in the Vector network interface. The base for these time stamps is a common hardware clock in the device.

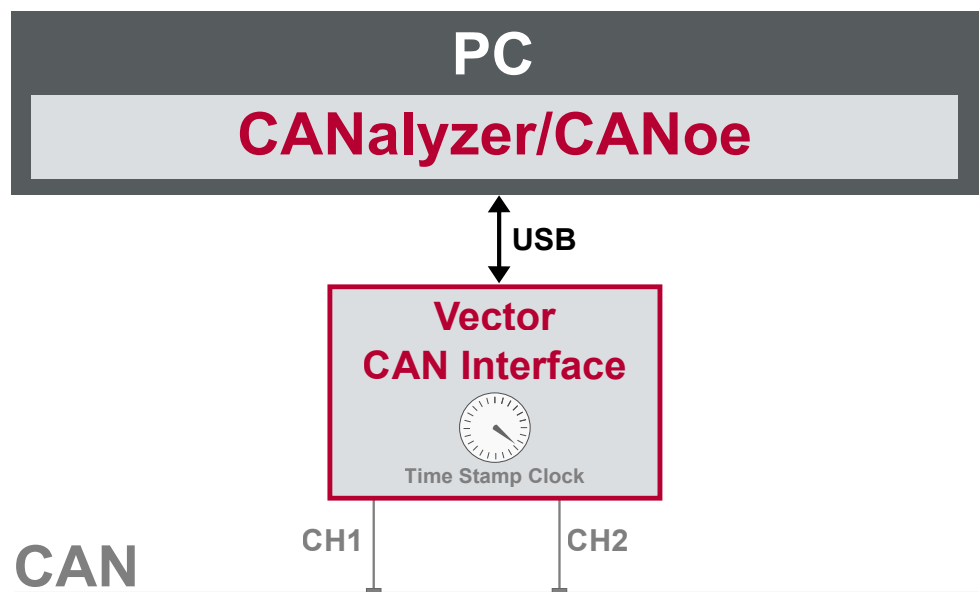

Figure 35: Common time stamp clock for each channel

If the measurement setup requires more than one Vector network interface, a synchronization of all connected interfaces and their hardware clocks is needed.

Due to manufacturing and temperature tolerances, the hardware clocks may vary in speed, so time stamps of various Vector devices drift over time.

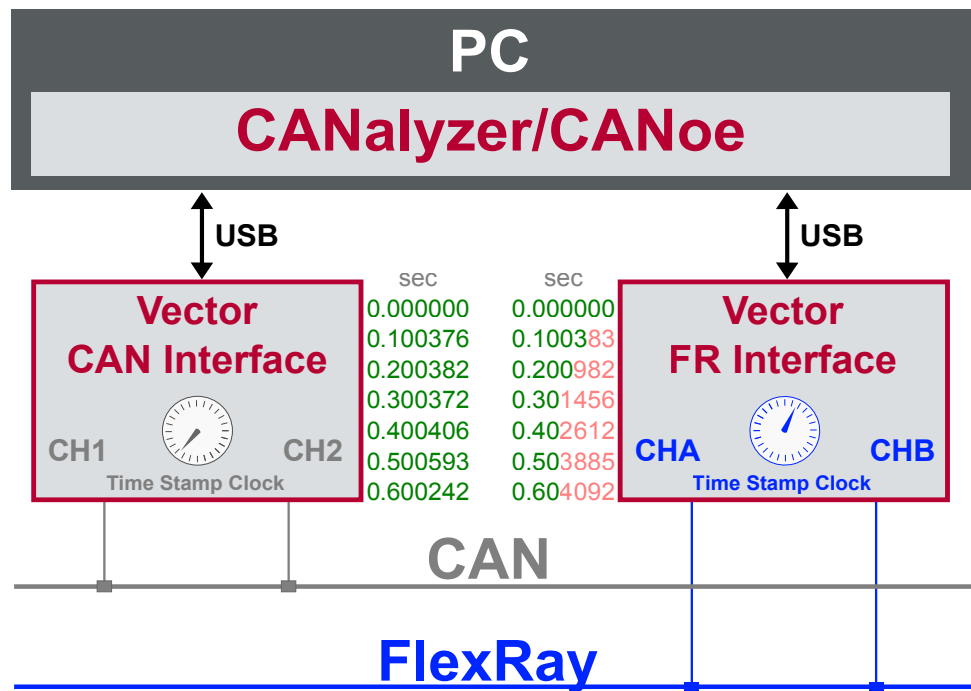

Figure 36: Example of unsynchronized network interfaces. Independent time stamps drift apart

To compensate for these time stamp deviations between the Vector network interfaces, the time stamps can be either synchronized by software, hardware, PTP or GNSS (capability depends on the Vector device).

i **Note**
 The accuracy of the software, hardware, PTP or GNSS sync depends on the interface. Further information on specific values can be found in the technical data of the respective devices.

4.2 Software Sync

4.2.1 General Information

**Synchronization
by software**

The software time synchronization is not available for this device. Please use the hardware time synchronization instead (see section **Hardware Sync** on page 72).

4.3 Hardware Sync

4.3.1 General Information

Synchronization by hardware

A more accurate time synchronization of multiple devices is provided by the hardware synchronization. Two Vector network interfaces can therefore be connected with the SYNCcableXL (see accessories manual, part number 05018).

In order to synchronize up to five devices at the same time, a distribution box is available (see accessories manual, part number 05085).

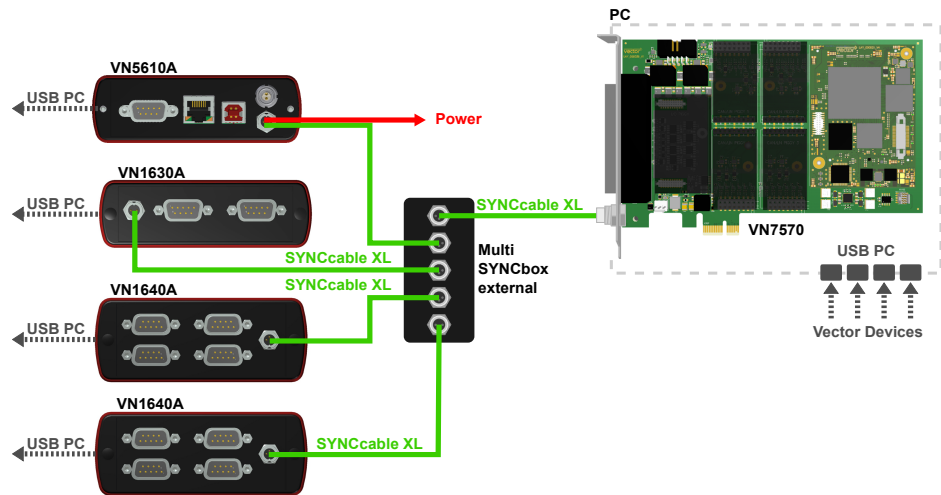

Figure 37: Example of a time synchronization with multiple devices

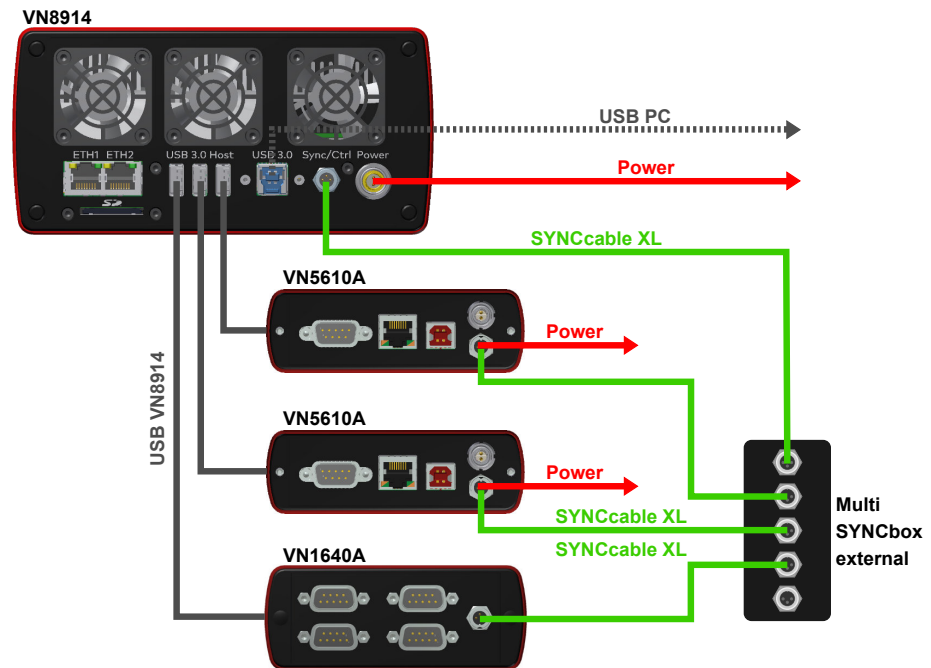

Figure 38: Example of a time synchronization with VN8914 and additional devices

At each falling edge on the sync line which is initiated by the driver, the Vector network interface generates a time stamp that is provided to the driver. This allows the driver to calculate the deviations between the network interfaces and to synchronize

the time stamps to a common time base (master clock) which can be defined by the user.

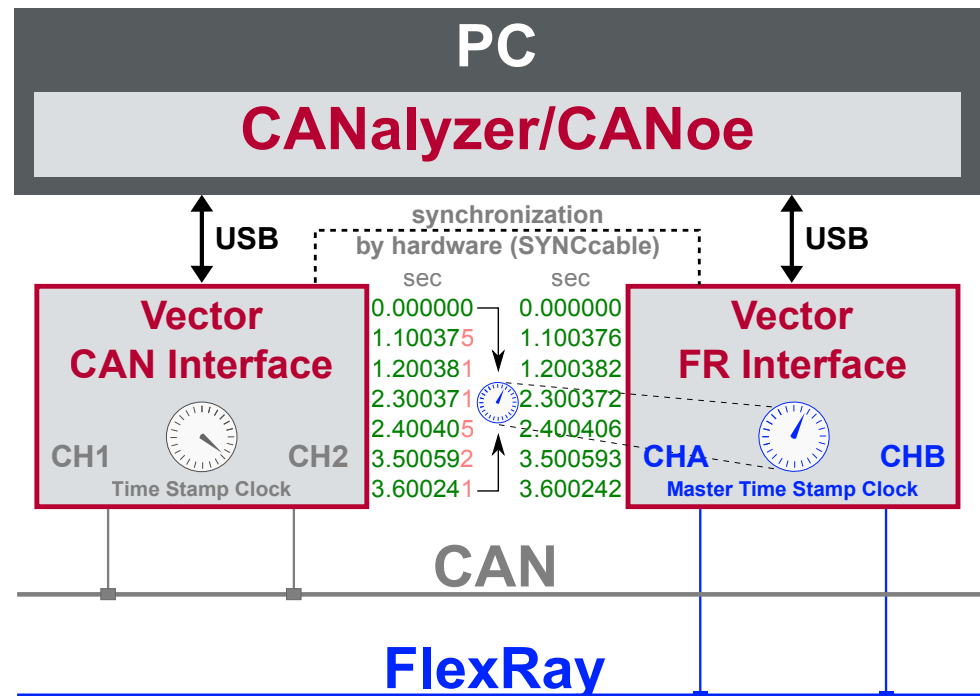

Figure 39: Time stamps are synchronized to the master clock

4.3.2 Configuration

Vector
Hardware Manager

Use hardware synchronization if at least one device is connected with USB or PCIe to the PC and all devices are hardware sync capable. One device should be configured as master and all other devices as slaves. Therefore, all devices must be interconnected with SYNCcableXL and Multi SYNCbox external or SYNCbox active.



Reference

Further details and tips on the time sync configuration can be found in the Vector Hardware Manager help in section **User Interface | Navigation Rail | Time Sync**.

5 Important Notes - Details

In this chapter you find the following information:

5.1 Safety Instructions and Hazard Warnings	75
5.1.1 Proper Use and Intended Purpose	75
5.1.2 Hazards	76
5.2 Disclaimer	77
5.3 Licenses	78
5.3.1 GRUB Version 0.4.4-r61	78
5.3.2 AutoLaunch V310	78
5.4 Disposal of Vector Hardware	79

5.1 Safety Instructions and Hazard Warnings



Caution!

In order to avoid personal injuries and damage to property, you have to read and understand the following safety instructions and hazard warnings prior to installation and use of this interface. Keep this documentation (manual) always near the interface.

5.1.1 Proper Use and Intended Purpose



Caution!

The interface is designed for analyzing, controlling and otherwise influencing control systems and electronic control units. This includes, inter alia, bus systems like CAN, LIN, K-Line, MOST, FlexRay, Ethernet, BroadR-Reach and/or ARINC 429.

The interface may only be operated in a closed state. In particular, printed circuits must not be visible. The interface may only be operated (i) according to the instructions and descriptions of this manual; (ii) with the electric power supply designed for the interface, e.g. USB-powered power supply; and (iii) with accessories manufactured or approved by Vector.

The interface is exclusively designed for use by skilled personnel as its operation may result in serious personal injuries and damage to property. Therefore, only those persons may operate the interface who (i) have understood the possible effects of the actions which may be caused by the interface; (ii) are specifically trained in the handling with the interface, bus systems and the system intended to be influenced; and (iii) have sufficient experience in using the interface safely.

The knowledge necessary for the operation of the interface can be acquired in work-shops and internal or external seminars offered by Vector. Additional and interface specific information, such as „Known Issues“, are available in the „Vector KnowledgeBase“ on Vector’s website at www.vector.com. Please consult the „Vector KnowledgeBase“ for updated information prior to the operation of the interface.

5.1.2 Hazards



Caution!

The interface may control and/or otherwise influence the behavior of control systems and electronic control units. Serious hazards for life, body and property may arise, in particular, without limitation, by interventions in safety relevant systems (e.g. by deactivating or otherwise manipulating the engine management, steering, airbag and/or braking system) and/or if the interface is operated in public areas (e.g. public traffic, airspace). Therefore, you must always ensure that the interface is used in a safe manner. This includes, inter alia, the ability to put the system in which the interface is used into a safe state at any time (e.g. by „emergency shutdown“), in particular, without limitation, in the event of errors or hazards.

Comply with all safety standards and public regulations which are relevant for the operation of the system. Before you operate the system in public areas, it should be tested on a site which is not accessible to the public and specifically prepared for performing test drives in order to reduce hazards.

5.2 Disclaimer

**Caution!**

Claims based on defects and liability claims against Vector are excluded to the extent damages or errors are caused by improper use of the interface or use not according to its intended purpose. The same applies to damages or errors arising from insufficient training or lack of experience of personnel using the interface.

5.3 Licenses

5.3.1 GRUB Version 0.4.4-r61

Copyright and disclaimer

The product contains the software GRUB Version 0.4.4-r61. Copyright (C) 1989, 1991 Free Software Foundation, Inc. 59 Temple Place, Suite 330, Boston, MA 02111-1307 USA. This program is free software; you can redistribute it and/or modify it under the terms of the GNU General Public License as published by the Free Software Foundation, version 2 of the License. This program is distributed by the holder of the Copyright in the hope that it will be useful, but WITHOUT ANY WARRANTY by the holder of the Copyright; without even the implied warranty of MERCHANTABILITY or FITNESS FOR A PARTICULAR PURPOSE. See the GNU General Public License for more details.



Reference

The GNU GENERAL PUBLIC LICENSE can be found in the separate text file manual on the Vector Driver Disk in `\Documentation\Licenses`.

Source code

The product contains the software GRUB Version 0.4.4-r61. We will send anyone a complete machine-readable copy of the corresponding source code by email without any charge if so requested by writing to support@vector.com. This offer is valid for three years starting at the time you received the product.

5.3.2 AutoLaunch V310

Copyright and disclaimer

The product contains the software AutoLaunch V310. Copyright (c) 2011 Samuel Phung (Embedded101.com). Permission is hereby granted, free of charge, to any person obtaining a copy of this software and associated documentation files (the "Software"), to deal in the Software without restriction, including without limitation the rights to use, copy, modify, merge, publish, distribute, sublicense, and/or sell copies of the Software, and to permit persons to whom the Software is furnished to do so, subject to the following conditions: The above copyright notice and this permission notice shall be included in all copies or substantial portions of the Software.

5.4 Disposal of Vector Hardware

Please handle old devices responsibly and observe the environmental laws applicable in your country. Please dispose of the Vector hardware only at the designated places and not with the household waste.

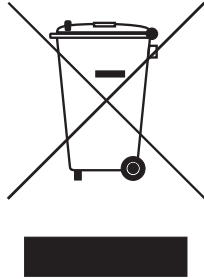

Within the European Community, the Directive on Waste Electrical and Electronic Equipment (WEEE Directive) and the Directive on the Restriction of the Use of Certain Hazardous Substances in Electrical and Electronic Equipment (RoHS Directive) apply.

For Germany and other EU countries, we offer free take-back of old Vector hardware.

Please carefully check the Vector hardware to be disposed of before shipping. Please remove all items that are not part of the original scope of delivery, e.g. storage media. The Vector hardware must also be free of licenses and must no longer contain any personal data. Vector does not perform any checks in this regard. Once the hardware has been shipped, it cannot be returned to you. By shipping the hardware to us, you have relinquished your rights to the hardware.

Before shipping, please register your old device via:

<https://www.vector.com/int/en/support-downloads/return-registration-for-the-disposal-of-vector-hardware/>

6 Wichtige Hinweise

In diesem Kapitel finden Sie die folgenden Informationen:

6.1 Sicherheits- und Gefahrenhinweise	81
6.1.1 Sach- und bestimmungsgemäßer Gebrauch	81
6.1.2 Gefahren	82
6.2 Haftungsausschluss	83
6.3 Lizenzen	84
6.3.1 GRUB Version 0.4.4-r61	84
6.3.2 AutoLaunch V310	84
6.4 Entsorgung von Vector Hardware	85

6.1 Sicherheits- und Gefahrenhinweise



Achtung!

Um Personen- und Sachschäden zu vermeiden, müssen Sie vor der Installation und dem Einsatz dieses Interfaces die nachfolgenden Sicherheits- und Gefahrenhinweise lesen und verstehen. Bewahren Sie diese Dokumentation (Handbuch) stets in der Nähe dieses Interfaces auf.

6.1.1 Sach- und bestimmungsgemäßer Gebrauch



Achtung!

Das Interface ist für die Analyse, die Steuerung sowie für die anderweitige Beeinflussung von Regelsystemen und Steuergeräten bestimmt. Das umfasst unter anderem die Bussysteme CAN, LIN, K-Line, MOST, FlexRay, Ethernet, BroadR-Reach oder ARINC 429.

Der Betrieb des Interfaces darf nur im geschlossenen Zustand erfolgen. Insbesondere dürfen keine Leiterplatten sichtbar sein. Das Interface ist entsprechend den Anweisungen und Beschreibungen dieses Handbuchs einzusetzen. Dabei darf nur die dafür vorgesehene Stromversorgung, wie z. B. USB-powered, Netzteil, und das Originalzubehör von Vector bzw. das von Vector freigegebene Zubehör verwendet werden.

Das Interface ist ausschließlich für den Einsatz durch geeignetes Personal bestimmt, da der Gebrauch dieses Interfaces zu erheblichen Personen- und Sachschäden führen kann. Deshalb dürfen nur solche Personen dieses Interface einsetzen, welche die möglichen Konsequenzen der Aktionen mit diesem Interface verstanden haben, speziell für den Umgang mit diesem Interface, den Bussystemen und dem zu beeinflussenden System geschult worden sind und ausreichende Erfahrung im sicheren Umgang mit dem Interface erlangt haben.

Die notwendigen Kenntnisse zum Einsatz dieses Interfaces können bei Vector über interne oder externe Seminare und Workshops erworben werden. Darüber hinausgehende und Interface-spezifische Informationen wie z. B. „Known Issues“ sind auf der Vector Webseite unter www.vector.com in der „Vector KnowledgeBase“ verfügbar. Bitte informieren Sie sich dort vor dem Betrieb des Interfaces über aktualisierte Hinweise.

6.1.2 Gefahren



Achtung!

Das Interface kann das Verhalten von Regelsystemen und Steuergeräten steuern und in anderweitiger Weise beeinflussen. Insbesondere durch Eingriffe in sicherheitsrelevante Bereiche (z. B. durch Deaktivierung oder sonstige Manipulation der Motorsteuerung, des Lenk-, Airbag-, oder Bremssystems) und/oder der Einsatz des Interfaces in öffentlichen Räumen (z. B. Straßenverkehr, Luftraum) können erhebliche Gefahren für Leib, Leben und Eigentum entstehen. Stellen Sie daher in jedem Fall eine gefahrfreie Verwendung sicher. Hierzu gehört unter anderem auch, dass das System, in dem das Interface eingesetzt wird, jederzeit, insbesondere bei Auftreten von Fehlern oder Gefahren, in einen sicheren Zustand geführt werden kann (z. B. durch Not-Abschaltung).

Beachten Sie alle sicherheitstechnischen Richtlinien und öffentlich-rechtlichen Vorschriften, die für den Einsatz des Systems relevant sind. Zur Verminderung von Gefahren sollte das System vor dem Einsatz in öffentlichen Räumen auf einem nicht-öffentlich zugänglichen und für Testfahrten bestimmten Gelände erprobt werden.

6.2 Haftungsausschluss



Achtung!

Soweit das Interface nicht sach- oder bestimmungsgemäß eingesetzt wird, übernimmt Vector keine Gewährleistung oder Haftung für dadurch verursachte Schäden oder Fehler. Das Gleiche gilt für Schäden oder Fehler, die auf einer mangelnden Schulung oder Erfahrung derjenigen Personen beruhen, die das Interface einsetzen.

6.3 Lizenzen

6.3.1 GRUB Version 0.4.4-r61

Copyright and disclaimer

The product contains the software GRUB Version 0.4.4-r61. Copyright (C) 1989, 1991 Free Software Foundation, Inc. 59 Temple Place, Suite 330, Boston, MA 02111-1307 USA. This program is free software; you can redistribute it and/or modify it under the terms of the GNU General Public License as published by the Free Software Foundation, version 2 of the License. This program is distributed by the holder of the Copyright in the hope that it will be useful, but WITHOUT ANY WARRANTY by the holder of the Copyright; without even the implied warranty of MERCHANTABILITY or FITNESS FOR A PARTICULAR PURPOSE. See the GNU General Public License for more details.



Verweis

The GNU GENERAL PUBLIC LICENSE can be found in the separate text file manual on the Vector Driver Disk in `\Documentation\Licenses`.

Source code

The product contains the software GRUB Version 0.4.4-r61. We will send anyone a complete machine-readable copy of the corresponding source code by email without any charge if so requested by writing to support@vector.com. This offer is valid for three years starting at the time you received the product.

6.3.2 AutoLaunch V310

Copyright and disclaimer

The product contains the software AutoLaunch V310. Copyright (c) 2011 Samuel Phung (Embedded101.com). Permission is hereby granted, free of charge, to any person obtaining a copy of this software and associated documentation files (the "Software"), to deal in the Software without restriction, including without limitation the rights to use, copy, modify, merge, publish, distribute, sublicense, and/or sell copies of the Software, and to permit persons to whom the Software is furnished to do so, subject to the following conditions: The above copyright notice and this permission notice shall be included in all copies or substantial portions of the Software.

6.4 Entsorgung von Vector Hardware

Bitte gehen Sie verantwortungsvoll mit Altgeräten um und beachten Sie die in Ihrem Land geltenden Umweltgesetze. Entsorgen Sie die Vector Hardware bitte nur bei den dafür vorgesehenen Stellen und nicht über den Hausmüll.

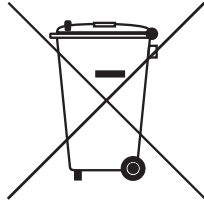

Innerhalb der Europäischen Gemeinschaft gelten die Richtlinie über Elektro- und Elektronik-Altgeräte (WEEE-Richtlinie) und die Richtlinie zur Beschränkung der Verwendung bestimmter gefährlicher Stoffe in Elektro- und Elektronikgeräten (RoHS-Richtlinie).

Für Deutschland und andere EU-Länder bieten wir Ihnen eine kostenlose Rücknahme der alten Vector Hardware an.

Bitte überprüfen Sie die zu entsorgende Vector Hardware vor dem Versand sorgfältig. Bitte entfernen Sie alle Gegenstände, die nicht zum ursprünglichen Lieferumfang gehören, z. B. Speichermedien. Die Vector Hardware muss außerdem frei von Lizenzen sein und darf keine personenbezogenen Daten mehr enthalten. Vector führt keine Kontrollen diesbezüglich durch. Sobald die Hardware versandt wurde, kann sie nicht mehr an Sie zurück geliefert werden. Mit dem Versand der Hardware an uns haben Sie Ihre Rechte an der Hardware abgetreten. Bitte melden Sie vor dem Versand Ihr Altgerät an über:

<https://www.vector.com/de/de/support-downloads/return-registration-for-the-disposal-of-vector-hardware/>



Visit our website for:

- ▶ News
- ▶ Products
- ▶ Demo software
- ▶ Support
- ▶ Training classes
- ▶ Addresses